

Installation Manual

Passive Harmonic Filters



ECOsine® Economy Line &
ECOsine® Economy Line LV



ECOsine® Economy Line & ECOsine® Economy Line LV

FN3416 (50Hz) & FN3418 (60Hz)

FN3416LV (50Hz) & FN3418LV (60Hz) for 200V-240V

February 2016

Schaffner ECOsine® harmonic filters represent an economical solution to the challenge of load-applied harmonics mitigation in three-phase power systems. With a plug-and-play approach and more compact dimensions than comparable products, they can be quickly installed and easily commissioned. They increase the reliability and service life of electrical installations, help utilize electric system capacity better, and are the key to meet Power Quality standards such EN61000-3-12. ECOsine® filters help to reduce the costly waste of electricity.

This installation manual is intended to support designers, installers, and application engineers with filter selection, installation, application and maintenance. For additional helpful tips for overcoming harmonics mitigation challenges, please also consult the more detailed user manual of the ECOsine® FN3410 (50Hz) and FN3412 (60Hz) full performance filters.

If you require additional support, please feel free to contact your local Schaffner partner.



Important user notice

Schaffner ECOsine® harmonic filters are designed for the operation on the input (grid) side of power electronic equipment with six-pulse rectifier front-ends in balanced three-phase power systems, like typically used in AC or DC motor drives and high power DC supplies. Filter suitability for a given application must be determined by the user on a case by case basis. Schaffner will not assume liability for any consequential downtimes or damages resulting from use or application ECOsine® filters outside of their specifications. ECOsine® filters are not designed for single-phase or split-phase applications.

ECOsine® filters with protection category IP20/NEMA1 must be mounted in a clean, dry location. Contaminants such as oils, corrosive vapors and abrasive debris must be kept out of the enclosure. These filter enclosures are intended for indoor use, primarily to provide a degree of protection against contact with enclosed equipment. These enclosures offer no protection against airborne contaminants.

Important safety considerations



Note: Filter installation has to be carried out by a trained and certified electrician or technician, who is familiar with installation and safety procedures in three-phase power systems.

Warning: High voltage potentials are involved in the operation of ECOsine® filters. Always remove power before handling energized parts of the filter, and let ample time elapse (> 1 minute) for the capacitors to discharge to safe levels.

Warning: Follow the installation instructions closely. Ensure that fans and cooling slots are free from obstructions that could inhibit efficient air circulation. Do not operate the filter in ambient conditions outside of specifications.

Note: Do not operate ECOsine® filters on unsymmetrical loads, on linear loads, or with single-phase equipment.

Note: Always use an upstream disconnect or protection device as required by most national and international electric codes.

Note: Always connect the filter to protective earth (PE) first, then continue with the wiring of the phase connectors.

Note: Follow the Schaffner instructions closely when doing maintenance work. Use exclusively spare parts recommended and approved by Schaffner.

Note: Always practice the safety instructions defined by your company when handling, installing, operating, or maintaining ECOsine® harmonic filters.

Note: In case of uncertainty and questions please contact your local Schaffner partner for assistance.



Content

1. Part number coding	5
2. Filter description	6
2.1 General electrical specifications FN 3416 (50Hz filters).....	6
2.2 General electrical specifications FN 3418 (60Hz filters).....	7
2.3 General electrical specifications FN 3416LV (50Hz filters)	8
2.4 General electrical specifications FN 3418LV (60Hz filters)	9
2.5 Additional electrical specifications	10
2.6 Mechanical specifications	11
2.7 Performance characteristics FN3416 & FN3418	14
2.8 Performance characteristics FN3416LV & FN3418LV	16
2.9 Function diagram	18
2.10 External filter elements	19
2.11 Audible noise	20
3. Filter purpose and function.....	21
4. Filter selection	24
5. Filter application.....	27
6. Filter installation.....	29
7. Filter maintenance.....	34
8. Special considerations	36
8.1 Over-temperature contact and load disconnect.....	36
9. Troubleshooting	37
10. FAQ – Frequently asked questions	38
11. Custom design input form.....	41
Appendix I: International standards	43
I. Engineering recommendation G5/4-1	43
II. International standard EN 61000-3-12.....	45
III. IEEE Std 519.....	49
Appendix II: Declaration of conformity	50

1. Part number coding

FN 34xx xx -xxx -xx

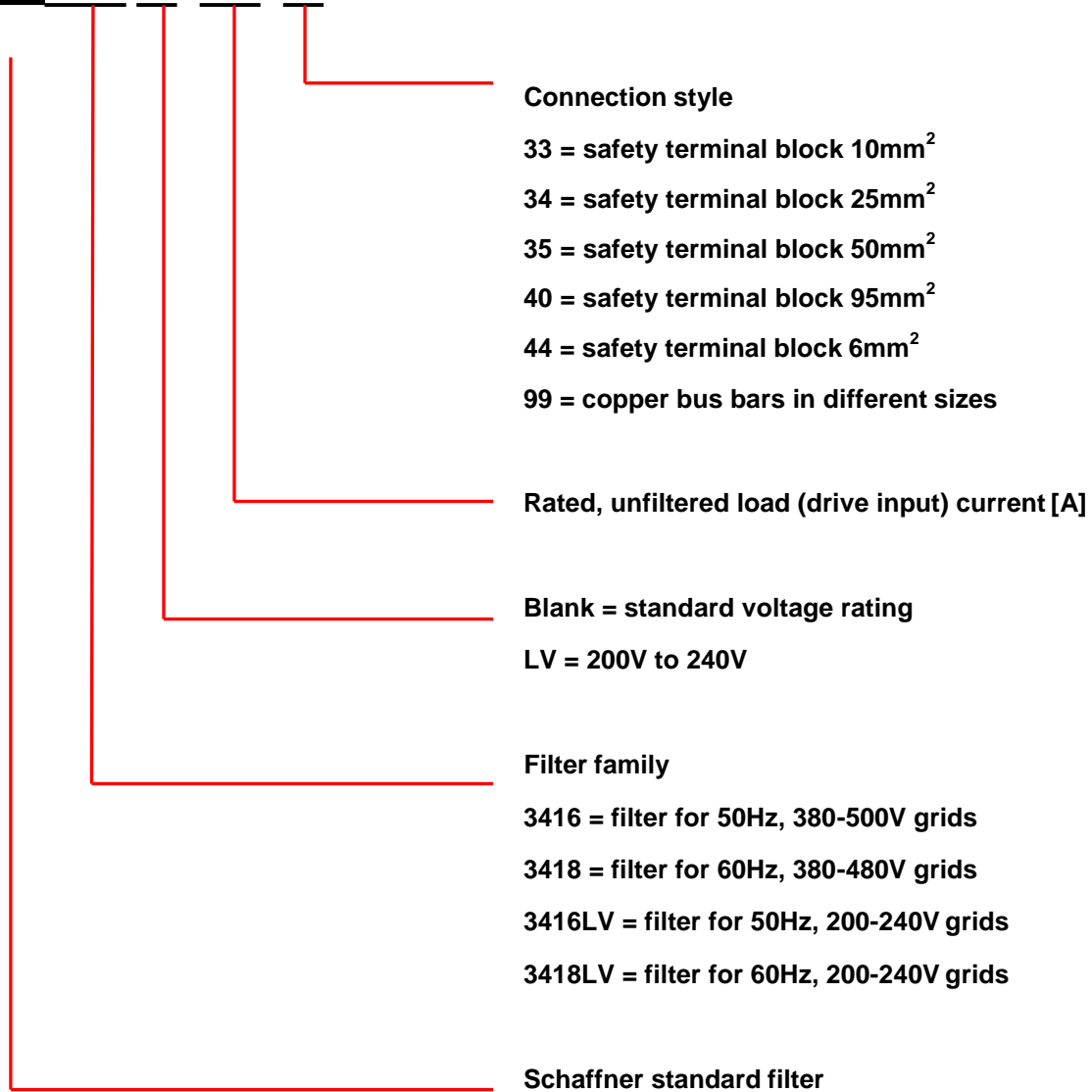

Examples:

FN 3416-60-34: Filter for 50Hz, 380-500V grids, 60A drive input current, with 25mm² terminals, for diode or SCR (thyristor) rectifier front-end.

FN 3418LV-240-99: Filter for 60Hz, 200-240V grids, 240A drive input current, with copper bus bar, for diode or SCR (thyristor) front-end.

2. Filter description

2.1 General electrical specifications FN 3416 (50Hz filters)

Nominal operating voltage:	3x 380 to 500VAC
Voltage tolerance range:	3x 342 to 550VAC
Operating frequency:	50Hz ±1Hz
Network:	TN, TT, IT
Nominal motor drive input current rating: ¹⁾	10 to 320A @ 45°C
Nominal filter input current rating: ¹⁾	7A _{rms} to 240A _{rms} @ 45°C
Nominal motor drive input power rating:	4 to 200kW
Total harmonic current distortion THID: ²⁾	According to EN61000-3-12, table 3 <10% @ rated power (with L _{dc}) <15% @ rated power (without L _{dc})
Total demand distortion TDD: ²⁾	According to IEEE 519
Partially weighted harmonic distortion PWHID:	<22% @ rated power
Efficiency:	>98% @ nominal line voltage and power
Drive dc-link voltage behavior: ³⁾	No load: +10% Full load: -5%
High potential test voltage: ⁴⁾	P → E 2500VAC (1min)
SCCR: ⁵⁾	100kA
Protection category:	IP20
Pollution degree:	1, 2 (according to EN 61800-5-1, EN 50178)
Cooling:	Natural convection cooling (4 to 7.5kW) Internal forced cooling (11kW and above)
Overload capability:	1.6x rated current for 1 minute, once per hour 2x rated current for 10 seconds, once per hour 5x rated current for 1 second, once per hour
Capacitive current at low load:	<30% of rated input current, at 400VAC <37% of rated input current, at 500VAC
Ambient temperature range:	-25°C to +45°C fully operational +45°C to +55°C derated operation ⁶⁾ -25°C to +70°C transportation and storage
Flammability class:	UL 94V-2 or better
Insulation class of magnetic components:	H (180°C)
Design corresponding to:	UL 508, EN 61558-2-20, CE (LVD 2006/95/EC)
MTBF @ 45°C/500V (Mil-HB-217F):	200'000 hours
MTTR:	<15 minutes (capacitors and fans)
Lifetime (calculated):	Min. 15 years
Safety monitoring functions:	Over-temperature of magnetic components
Safety monitor output signal:	NO switch

¹⁾ ECOSine® filters reduce RMS input and peak current by reducing harmonic currents and improving true power factor.

²⁾ System requirements: THVD <2%, line voltage unbalance <1%
 Performance specification for six-pulse diode rectifiers. SCR rectifier front-ends produce different results, depending upon the firing angle of the thyristors.

³⁾ Conditions: line impedance <3%

⁴⁾ Repetitive tests to be performed at max. 80% of above levels, for 2 seconds.

⁵⁾ External UL-rated fuses required.

⁶⁾ $I_{derated} = I_{nominal} \cdot \sqrt{(70^{\circ}\text{C} - T_{amb})/25^{\circ}\text{C}}$

2.2 General electrical specifications FN 3418 (60Hz filters)

Nominal operating voltage:	3x 380 to 480VAC
Voltage tolerance range:	3x 342 to 528VAC
Operating frequency:	60Hz ±1Hz
Network:	TN, TT, IT
Nominal motor drive input current rating: ¹⁾	8 to 310A @ 45°C
Nominal filter input current rating: ¹⁾	5A _{rms} to 250A _{rms} @ 45°C
Nominal motor drive input power rating:	5 to 250HP
Total harmonic current distortion THID: ²⁾	According to EN61000-3-12, table 3 <10% @ rated power (with L _{dc}) <15% @ rated power (without L _{dc})
Total demand distortion TDD: ²⁾	According to IEEE 519
Partially weighted harmonic distortion PWHID:	<22% @ rated power
Efficiency:	>98% @ nominal line voltage and power
Drive dc-link voltage behavior: ³⁾	No load: +10% Full load: -5%
High potential test voltage: ⁴⁾	P → E 2500VAC (1min)
SCCR: ⁵⁾	100kA
Protection category:	IP20
Pollution degree:	1, 2 (according to EN 61800-5-1, EN 50178)
Cooling:	Natural convection cooling (5 to 15HP) Internal forced cooling (20HP and above)
Overload capability:	1.6x rated current for 1 minute, once per hour 2x rated current for 10 seconds, once per hour 5x rated current for 1 second, once per hour
Capacitive current at low load:	<30% of rated input current, at 460VAC
Ambient temperature range:	-25°C to +45°C fully operational +45°C to +55°C derated operation ⁶⁾ -25°C to +70°C transportation and storage
Flammability class:	UL 94V-2 or better
Insulation class of magnetic components:	H (180°C)
Design corresponding to:	UL 508, EN 61558-2-20, CE (LVD 2006/95/EC)
MTBF @ 45°C/460V (Mil-HB-217F):	200'000 hours
MTTR:	<15 minutes (capacitors and fans)
Lifetime (calculated):	Min. 15 years
Safety monitoring functions:	Over-temperature of magnetic components
Safety monitor output signal:	NO switch

- ¹⁾ ECOSine® filters reduce RMS input and peak current by reducing harmonic currents and improving true power factor.
- ²⁾ System requirements: THVD <2%, line voltage unbalance <1%
 Performance specification for six-pulse diode rectifiers. SCR rectifier front-ends produce different results, depending upon the firing angle of the thyristors.
- ³⁾ Conditions: line impedance <3%
- ⁴⁾ Repetitive tests to be performed at max. 80% of above levels, for 2 seconds.
- ⁵⁾ External UL-rated fuses required.
- ⁶⁾ $I_{derated} = I_{nominal} * \sqrt{(70^{\circ}C - T_{amb}) / 25^{\circ}C}$

2.3 General electrical specifications FN 3416LV (50Hz filters)

Nominal operating voltage:	3x 200 to 240VAC
Voltage tolerance range:	3x 180 to 264VAC
Operating frequency:	50Hz ±1Hz
Network:	TN, TT, IT
Nominal motor drive input current rating: ¹⁾	10 to 320A @ 45°C
Nominal filter input current rating: ¹⁾	7A _{rms} to 240A _{rms} @ 45°C
Nominal motor drive input power rating:	2.5 to 90kW
Total harmonic current distortion THID: ²⁾	According to EN61000-3-12, table 3 <7% @ rated power (with L _{dc}) <13% @ rated power (without L _{dc})
Total demand distortion TDD: ²⁾	According to IEEE 519
Partially weighted harmonic distortion PWHID:	<22% @ rated power
Efficiency:	>98% @ nominal line voltage and power
Drive dc-link voltage behavior: ³⁾	No load: +10% Full load: -5%
High potential test voltage: ⁴⁾	P → E 2500VAC (1min)
SCCR: ⁵⁾	100kA
Protection category:	IP20
Pollution degree:	1, 2 (according to EN 61800-5-1, EN 50178)
Cooling:	Natural convection cooling (4 to 7.5kW) Internal forced cooling (11kW and above)
Overload capability:	1.6x rated current for 1 minute, once per hour 2x rated current for 10 seconds, once per hour 5x rated current for 1 second, once per hour
Capacitive current at low load:	<30% of rated input current, at 400VAC <37% of rated input current, at 500VAC
Ambient temperature range:	-25°C to +45°C fully operational +45°C to +55°C derated operation ⁶⁾ -25°C to +70°C transportation and storage
Flammability class:	UL 94V-2 or better
Insulation class of magnetic components:	H (180°C)
Design corresponding to:	UL 508, EN 61558-2-20, CE (LVD 2006/95/EC)
MTBF @ 45°C/500V (Mil-HB-217F):	200'000 hours
MTTR:	<15 minutes (capacitors and fans)
Lifetime (calculated):	Min. 15 years
Safety monitoring functions:	Over-temperature of magnetic components
Safety monitor output signal:	NO switch

- ¹⁾ ECOSine® filters reduce RMS input and peak current by reducing harmonic currents and improving true power factor.
²⁾ System requirements: THVD <2%, line voltage unbalance <1%
 Performance specification for six-pulse diode rectifiers. SCR rectifier front-ends produce different results, depending upon the firing angle of the thyristors.
³⁾ Conditions: line impedance <3%
⁴⁾ Repetitive tests to be performed at max. 80% of above levels, for 2 seconds.
⁵⁾ External UL-rated fuses required.
⁶⁾ $I_{\text{derated}} = I_{\text{nominal}} \cdot \sqrt{(70^{\circ}\text{C} - T_{\text{amb}}) / 25^{\circ}\text{C}}$

2.4 General electrical specifications FN 3418LV (60Hz filters)

Nominal operating voltage:	3x 200 to 240VAC
Voltage tolerance range:	3x 180 to 264VAC
Operating frequency:	60Hz ±1Hz
Network:	TN, TT, IT
Nominal motor drive input current rating: ¹⁾	8 to 310A @ 45°C
Nominal filter input current rating: ¹⁾	5A _{rms} to 250A _{rms} @ 45°C
Nominal motor drive input power rating:	2.5 to 125HP
Total harmonic current distortion THID: ²⁾	According to EN61000-3-12, table 3 <7% @ rated power (with L _{dc}) <13% @ rated power (without L _{dc})
Total demand distortion TDD: ²⁾	According to IEEE 519
Partially weighted harmonic distortion PWHID:	<22% @ rated power
Efficiency:	>98% @ nominal line voltage and power
Drive dc-link voltage behavior: ³⁾	No load: +10% Full load: -5%
High potential test voltage: ⁴⁾	P → E 2500VAC (1min)
SCCR: ⁵⁾	100kA
Protection category:	IP20
Pollution degree:	1, 2 (according to EN 61800-5-1, EN 50178)
Cooling:	Natural convection cooling (5 to 15HP) Internal forced cooling (20HP and above)
Overload capability:	1.6x rated current for 1 minute, once per hour 2x rated current for 10 seconds, once per hour 5x rated current for 1 second, once per hour
Capacitive current at low load:	<30% of rated input current, at 460VAC
Ambient temperature range:	-25°C to +45°C fully operational +45°C to +55°C derated operation ⁶⁾ -25°C to +70°C transportation and storage
Flammability class:	UL 94V-2 or better
Insulation class of magnetic components:	H (180°C)
Design corresponding to:	UL 508, EN 61558-2-20, CE (LVD 2006/95/EC)
MTBF @ 45°C/460V (Mil-HB-217F):	200'000 hours
MTTR:	<15 minutes (capacitors and fans)
Lifetime (calculated):	Min. 15 years
Safety monitoring functions:	Over-temperature of magnetic components
Safety monitor output signal:	NO switch

¹⁾ ECOSine® filters reduce RMS input and peak current by reducing harmonic currents and improving true power factor.

²⁾ System requirements: THVD <2%, line voltage unbalance <1%
 Performance specification for six-pulse diode rectifiers. SCR rectifier front-ends produce different results, depending upon the firing angle of the thyristors.

³⁾ Conditions: line impedance <3%

⁴⁾ Repetitive tests to be performed at max. 80% of above levels, for 2 seconds.

⁵⁾ External UL-rated fuses required.

⁶⁾ $I_{derated} = I_{nominal} * \sqrt{(70°C - T_{amb}) / 25°C}$

2.5 Additional electrical specifications

ECOsine® passive general electrical specifications refer to operating altitudes up to 1000m a.s.l. (3300ft). Operation between 1000m and 4000m (3300ft and 13123ft) requires a derating according to the table below:

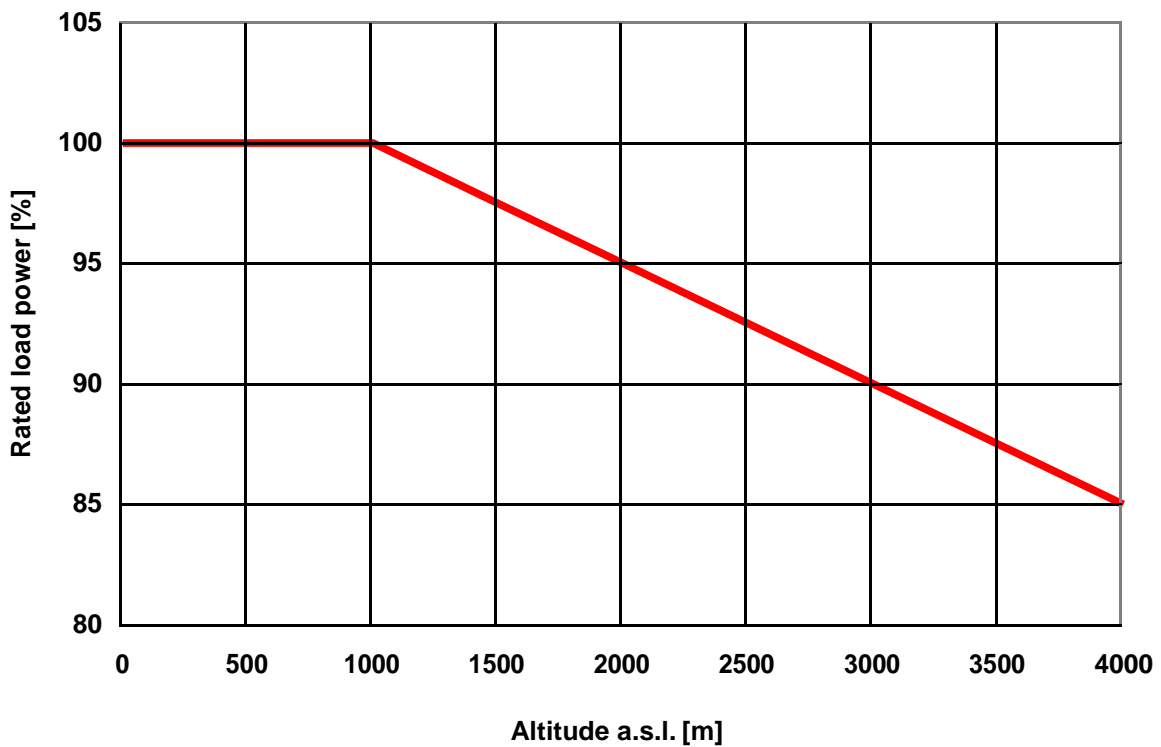

Note: do not use ECOsine® passive harmonic filters in altitudes above 4000m without consulting Schaffner first.

ECOsine® passive filters have been designed and certified acc. UL508, resp. UL508C, so there is no limitation in terms of altitude up to 4000m for clearance and creepage.

2.6 Mechanical specifications

Mechanical Data:

FN3416/ FN3416LV -10 to 110
FN3418/ FN3418LV -8 to 105

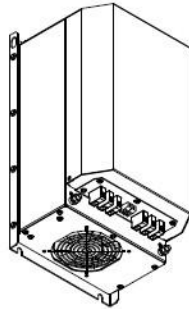
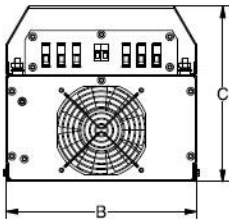

FN3416/ FN3416LV -150 to 210
FN3418/ FN3418LV -130 to 190

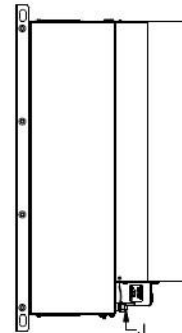
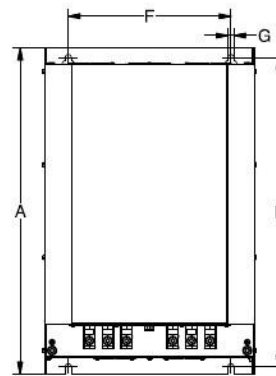
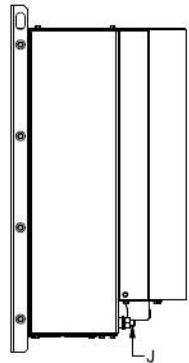
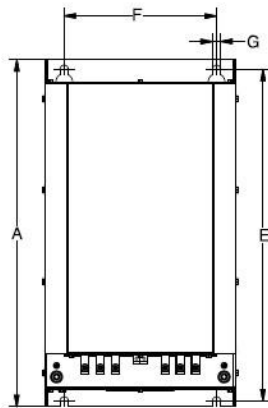
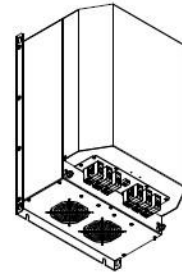
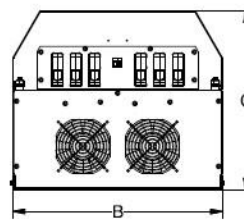

FN3416-260 to -320
FN3416/ FN3416LV -260 to 320
FN3418/ FN3418LV -240 to 310

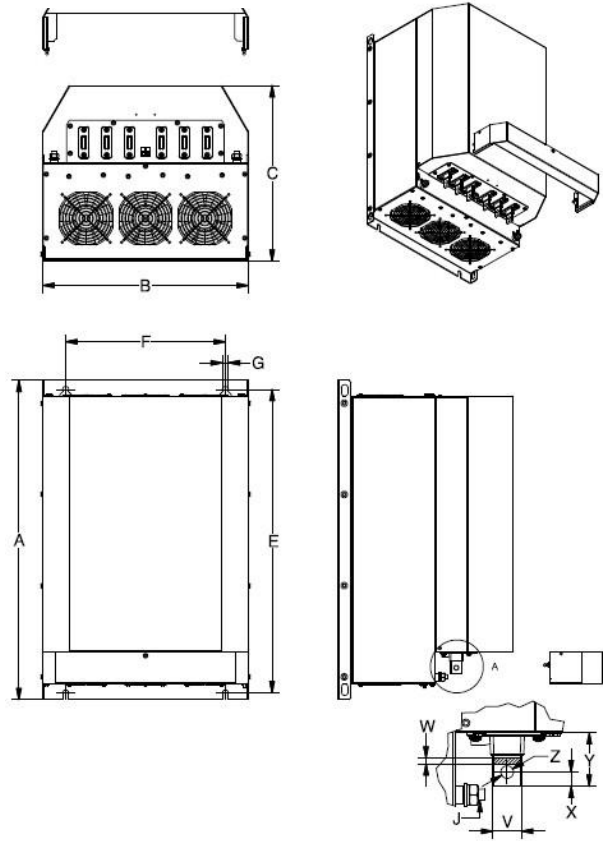





Dimensions

FN3416/ FN3416LV - ... FN3418/ FN3418LV - ...	10	13	16	24	32	38	45	60	75	90	110	150	180	210	260	320
	8	11	15	21	28	35	41	53	65	80	105	130	160	190	240	310
A	390	390	390	455	455	455	455	520	520	580	580	700	700	700	700	700
B	185	185	185	250	250	250	250	280	280	280	280	450	450	450	450	450
C	190	190	190	230	230	230	230	248	248	248	248	385	385	385	385	385
E	370	370	370	435	435	435	435	500	500	555	555	665	665	665	665	665
F	140	140	140	200	200	200	200	225	225	225	225	350	350	350	350	350
G	9	9	9	11	11	11	11	11	11	11	11	13	13	13	13	13
J	M6	M6	M6	M8	M8	M8	M8	M8	M8	M8	M10	M10	M10	M10	M10	M10
V																25
W																6
X																12.5
Y																47
Z																11

All dimensions in mm; 1 inch = 25.4 mm

Tolerances according to: ISO 2768-m / EN 22768-m

Filter connector cross sections

	-33	-34	-35	-40	-44
					
Solid wire	16 mm ²	35 mm ²	50 mm ²	95 mm ²	10 mm ²
Flex wire	10 mm ²	25 mm ²	50 mm ²	95 mm ²	6 mm ²
AWG type wire	AWG 6	AWG 2	AWG 1/0	AWG 4/0	AWG 8
Recommended torque	1.5-1.8 Nm	4.0-4.5 Nm	7-8 Nm	17-20 Nm	1.0-1.2 Nm

Please visit www.schaffner.com to find more details on filter connectors.

2.7 Performance characteristics FN3416 & FN3418

THID vs. load (diode rectifier front-ends)

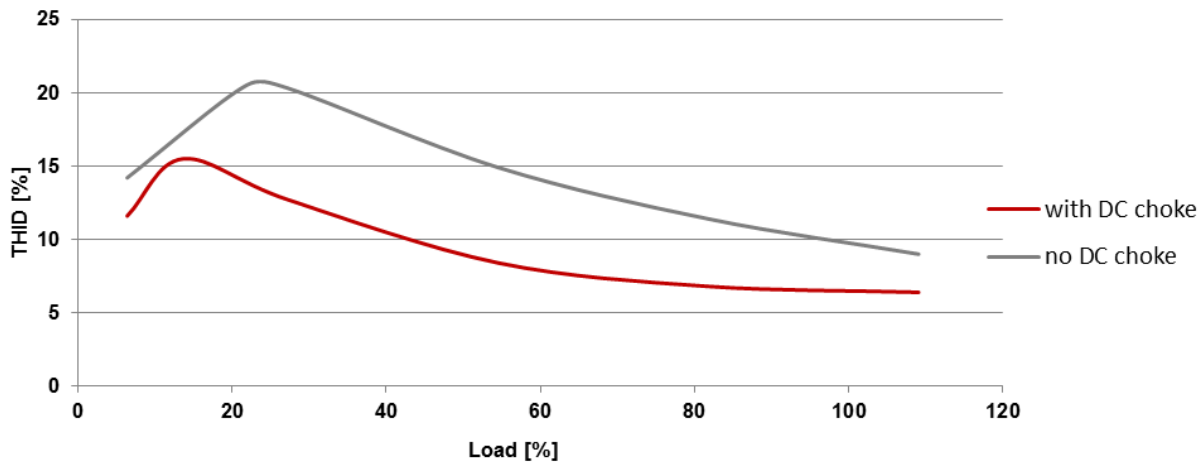

Note: shown above is the typical performance characteristic of FN3416/18 series in balanced diode rectifier front-end applications, with and without DC-link choke. In SCR rectifier applications, filter performance greatly depends upon the firing angle of the thyristors.

Note: the values of EMI-filter components present in the same non-linear load (e.g. motor drive) can influence the mitigation performance of passive harmonic filters. For Schaffner FN3418 (60Hz) filters the following boundary conditions exist for the smallest frame sizes:

Filter	Typical drive dc-link choke	Max. recommended EMI-filter X-capacitor	Expected THID *
FN3418-8-44	8.4mH	≤ 1.0μF	~10%
	-	≤ 2.2μF	~15%
FN3418-11-44	6.7mH	≤ 1.5μF	~10%
	-	≤ 1.5μF	~13%
FN3418-15-44	4.2mH	≤ 3.3μF	~10%
	-	≤ 3.3μF	~15%

* System requirements: THVD <2%, line voltage unbalance <1%

All other FN3416 and FN3418 filters are not subject to any such limitations.

Power factor vs. load (diode rectifier front-ends)

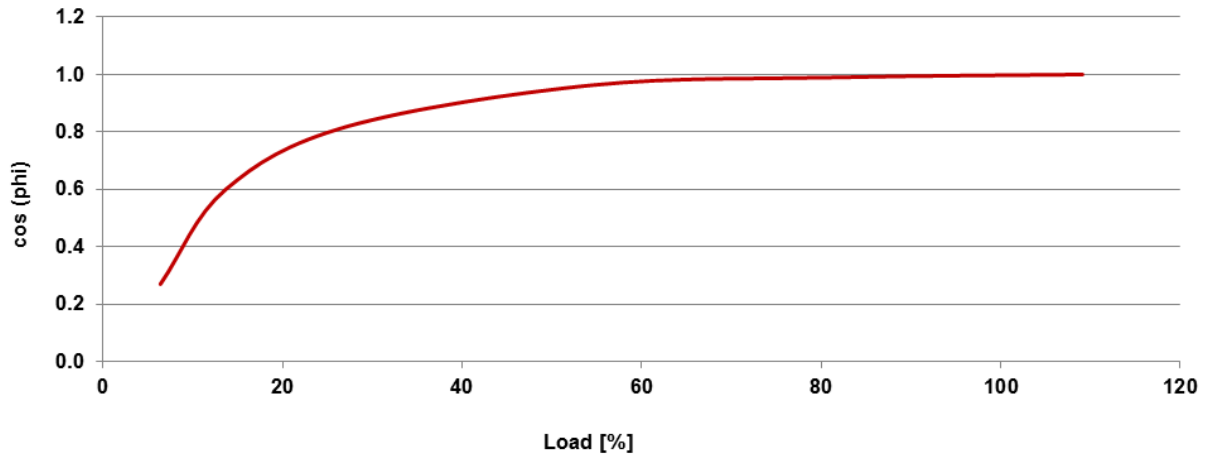

Note: in SCR rectifier applications, filter characteristics greatly depend upon the firing angle of the thyristors.

Drive dc-link voltage vs. load (diode rectifier front-ends)

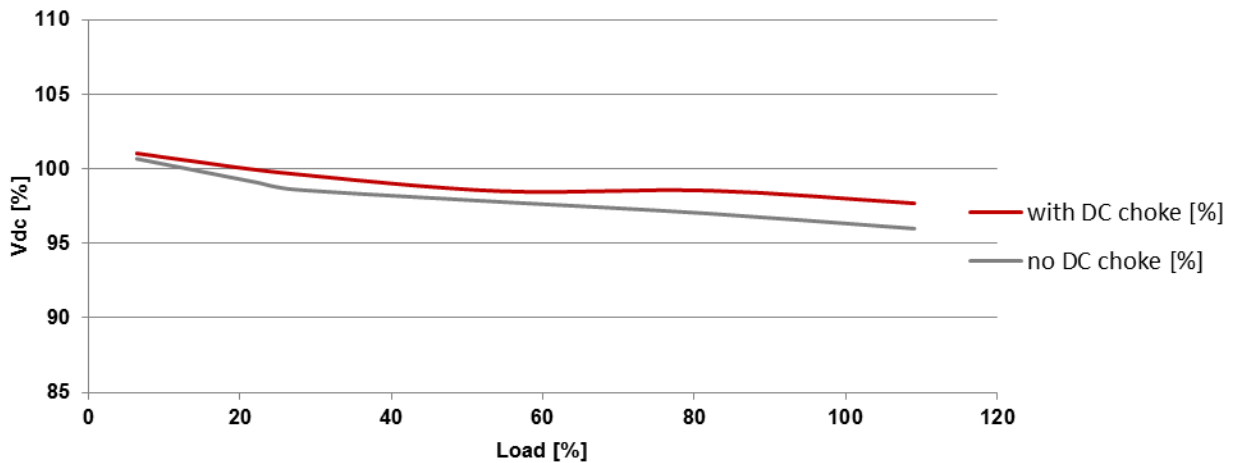

Note: in SCR rectifier applications, filter characteristics greatly depend upon the firing angle of the thyristors.

2.8 Performance characteristics FN3416LV & FN3418LV

THID vs. load (diode rectifier front-ends)

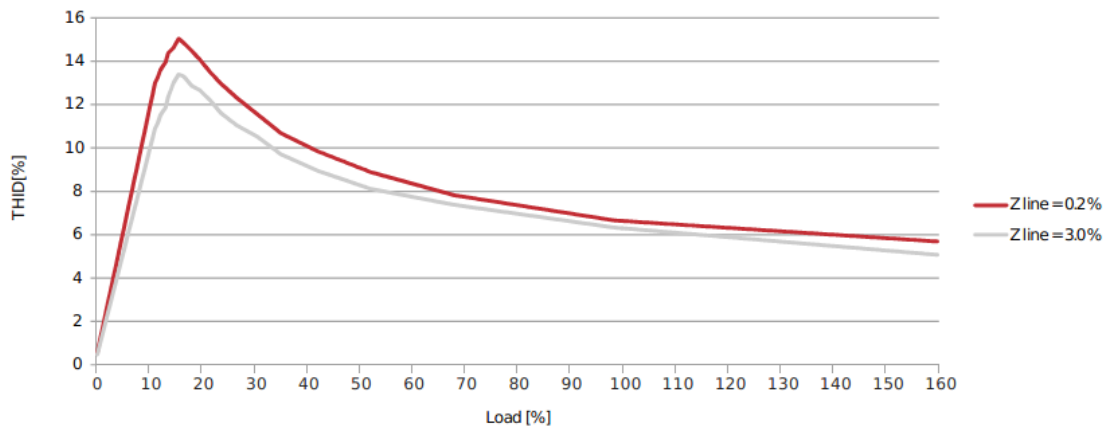

Note: shown above is the typical performance characteristic of FN3416LV/18LV series in balanced diode rectifier front-end. In SCR rectifier applications, filter performance greatly depends upon the firing angle of the thyristors.

Power factor vs. load (diode rectifier front-ends)

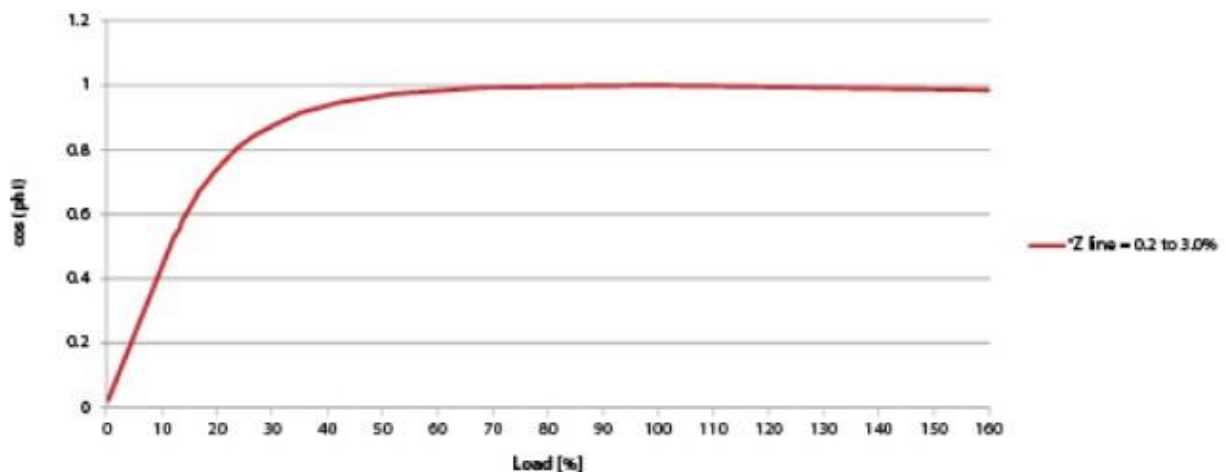

Note: in SCR rectifier applications, filter characteristics greatly depend upon the firing angle of the thyristors.

Drive dc-link voltage vs. load (diode rectifier front-ends)

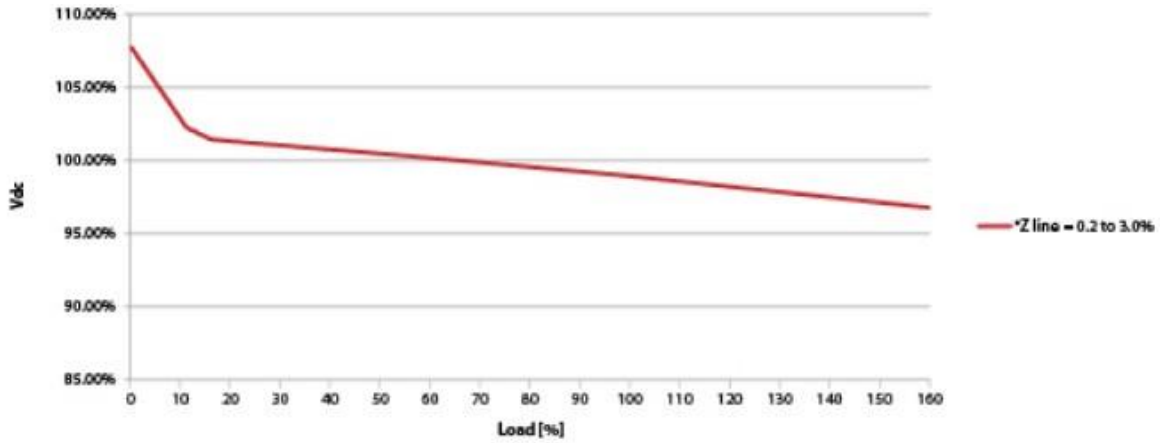

Note: in SCR rectifier applications, filter characteristics greatly depend upon the firing angle of the thyristors.

2.9 Function diagram

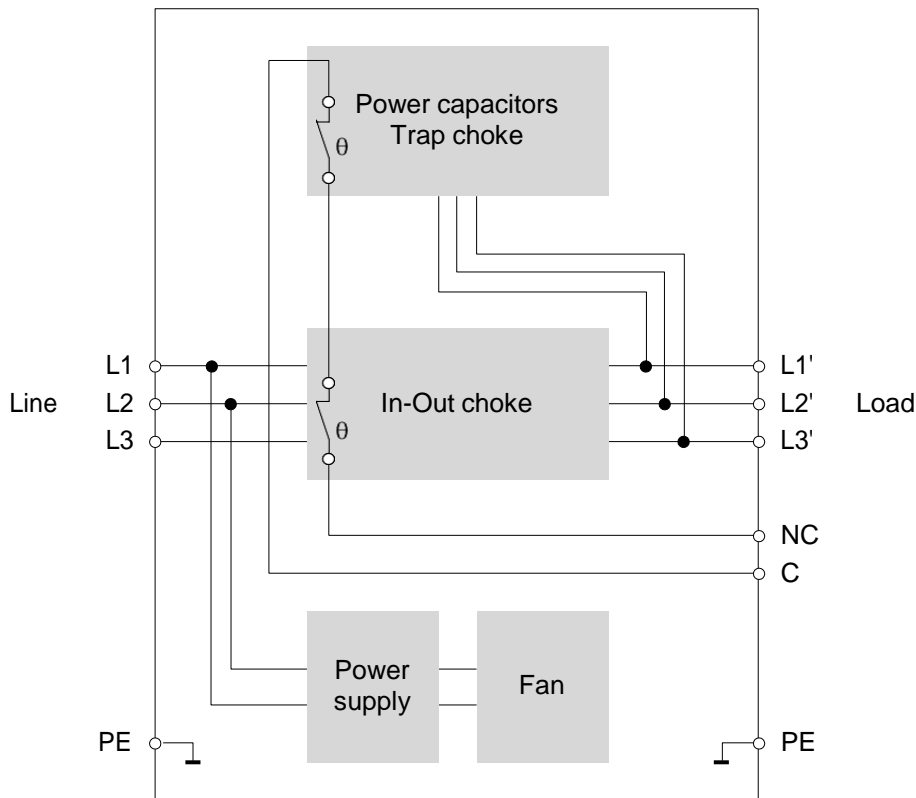

Filter terminals	Line	3 touch safe terminal blocks (busbar terminals >240A)
	Load	3 touch safe terminal blocks (busbar terminals >240A)
	Over-temperature contact	NC switch, 250VAC/2.5A, touch safe terminal 4mm ² Open position indicates error
	PE	Protective earth. Threaded studs with washer and nut
	Function blocks	Chokes
Capacitors		Power capacitors incl. discharge resistors
Fan *		Field replaceable fan for choke cooling (some models)
Power supply *		Internally generated 24VDC for fan supply (some models)

* the following filters do not require forced cooling and therefore have no internal fan and power supply:
 FN3416/FN3416LV -10, -13, -16; FN3418/FN3418LV -8, -11, -15.

2.10 External filter elements

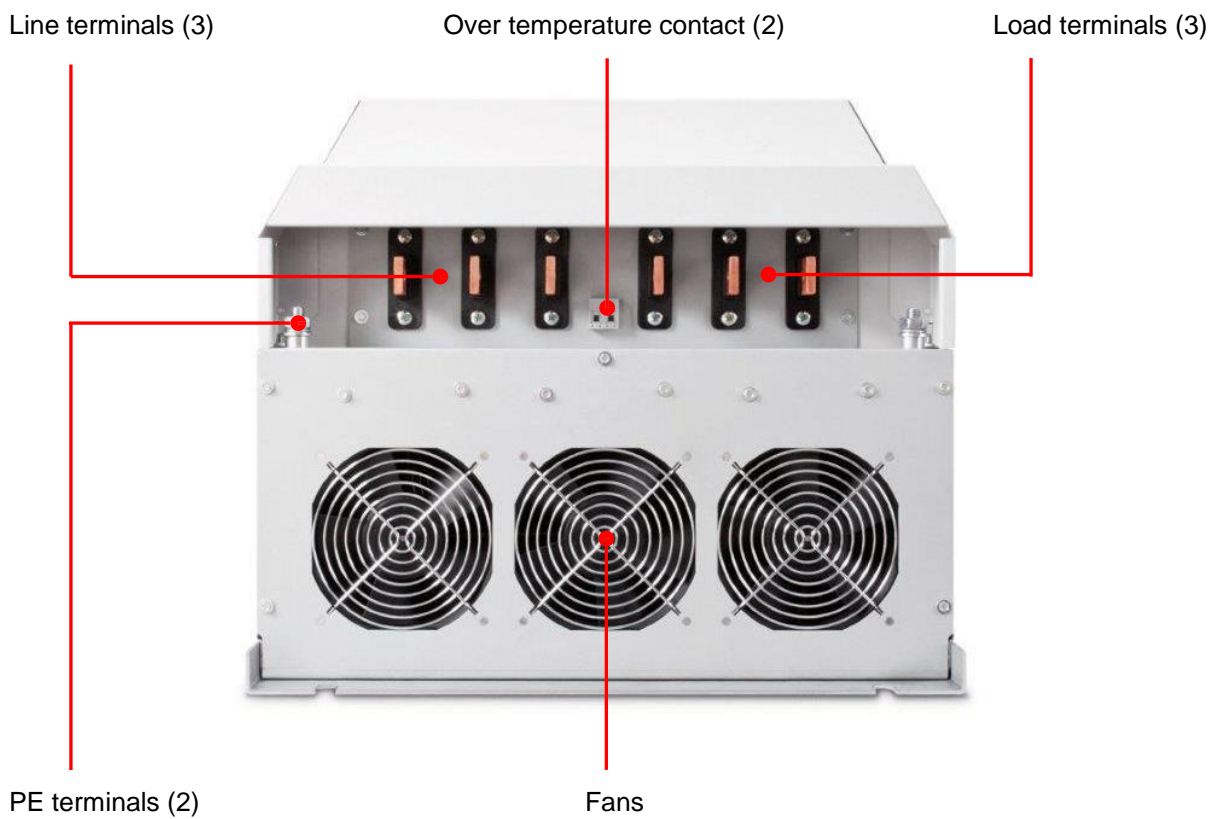
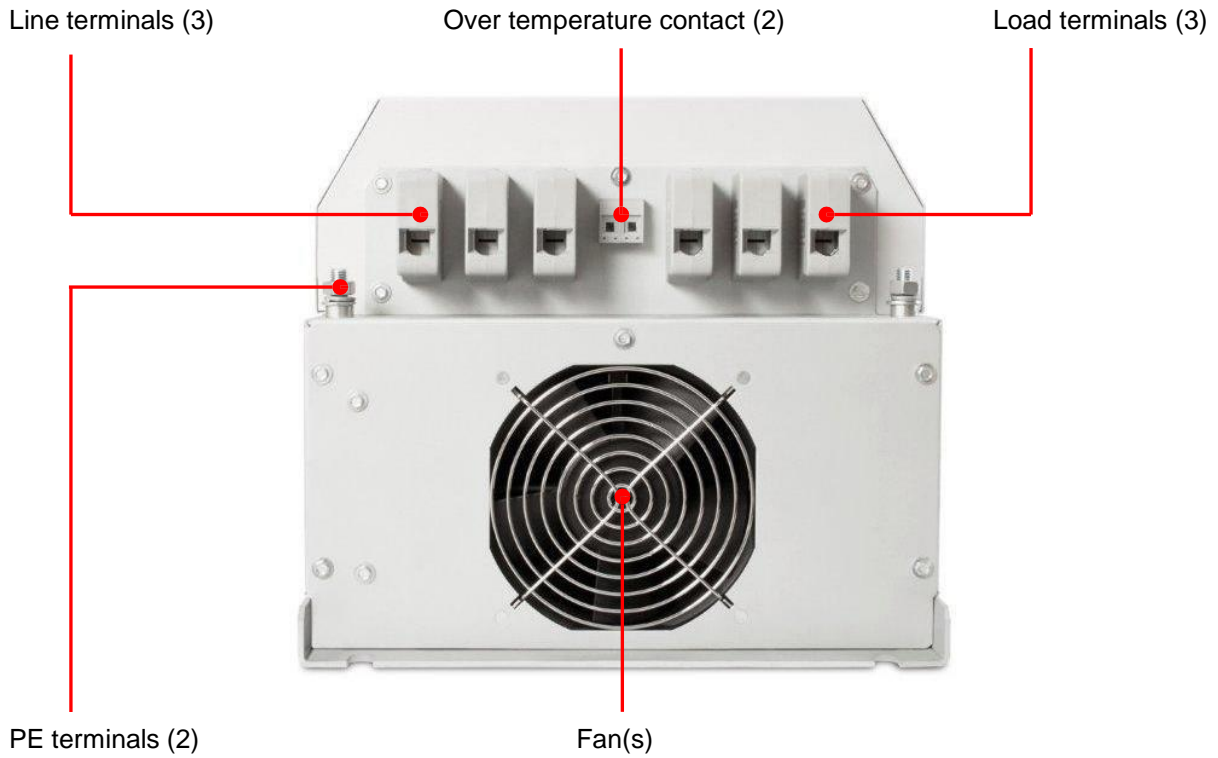

2.11 Audible noise

Tests have been performed at nominal filter load. Ambient noise level: 49dB[A]

Filter

FN 3416-13-44 (P=5.5kW)	60dB[A] @ 1m
-------------------------	--------------

FN 3416-210-40 (P=110kW)	70dB[A] @ 1m
--------------------------	--------------

Equipment used: Peak Tech Sound Level Meter 5055

3. Filter purpose and function

ECOsine® harmonic filters are based on passive LCR filtering technology. They are intended for the operation on the input side of balanced three-phase six-pulse rectifiers, like commonly used in inverters for motor drives.

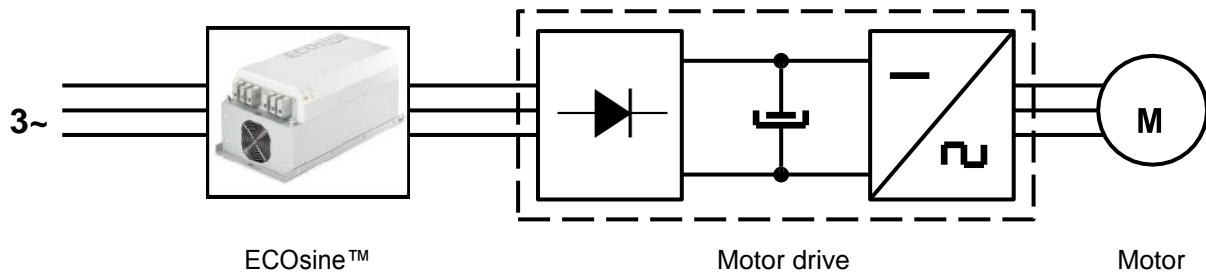

Six-pulse rectifiers inherently draw current in a non-sinusoidal fashion from the grid, creating a current wave form rich in harmonics. Harmonic currents flow through system impedances and create harmonic voltages. Both harmonic currents and voltages give raise to serious issues, such as electric system overload, reliability problems, and violations against international standards and utility codes.

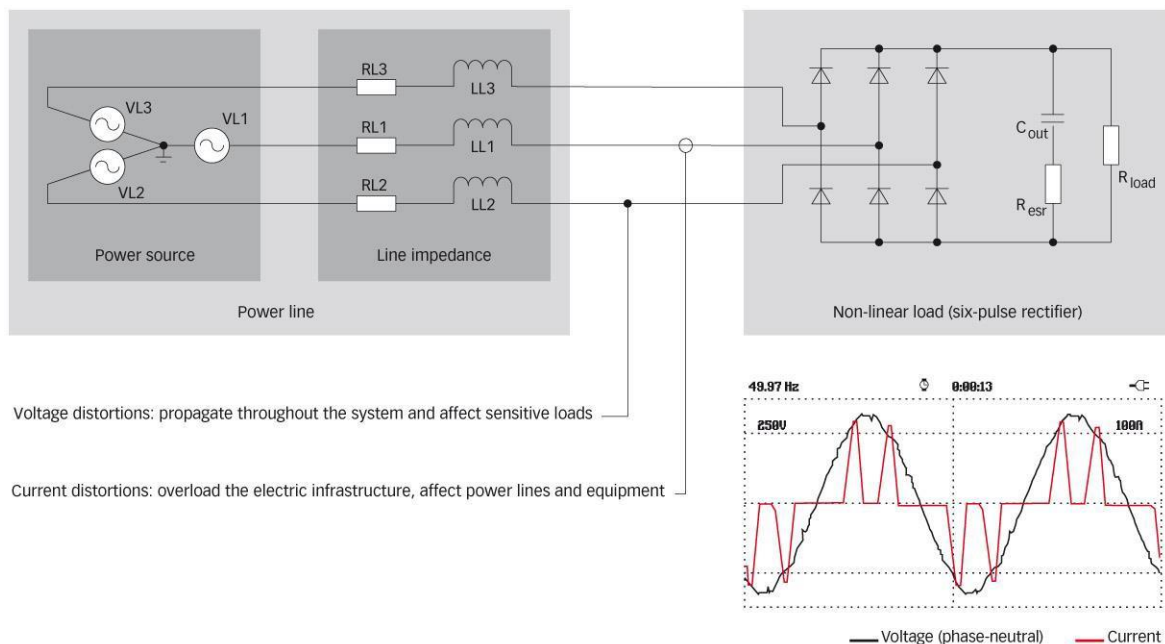

ECOsine® filters efficiently reduce the harmonic currents to negligible levels and ensure, that a sine-wave current is drawn from the grid. In the process, they also reduce peak currents and RMS input current, allowing for lower wire cross sections in conductors, smaller fuses, breakers, and transformers. In existing installations, more drives can be used on the same distribution transformer.

The examples on the next pages visualize typical performance test results with and without a Schaffner ECOsine® harmonic filter FN 3416-210-40 for the rated load power of 110kW.

Example 1: motor drive without built-in DC-link choke

Without ECOsine® filter

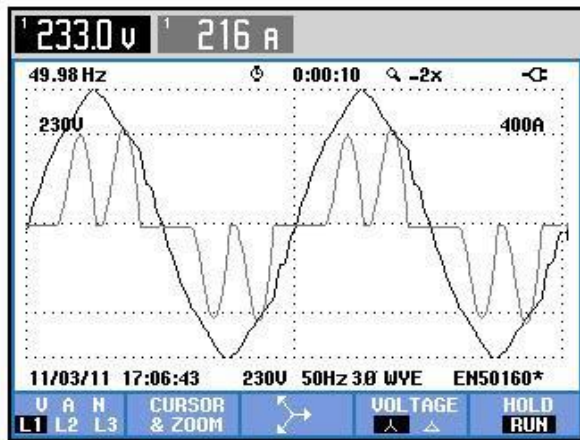

Voltage and current waveforms

With ECOsine® filter

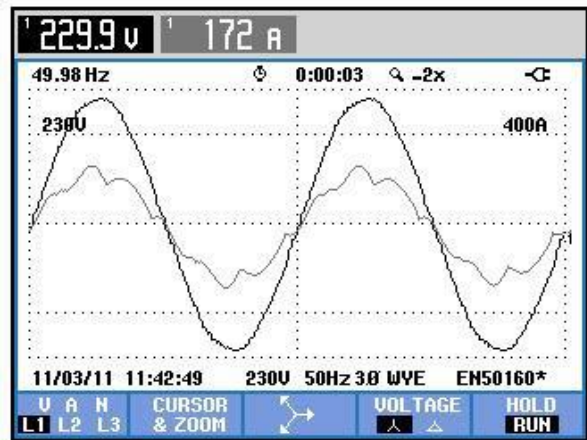

Voltage and current waveforms

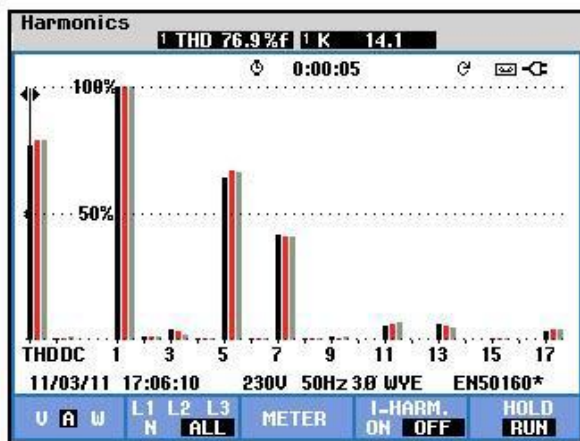

Current harmonics THD = 76.9%

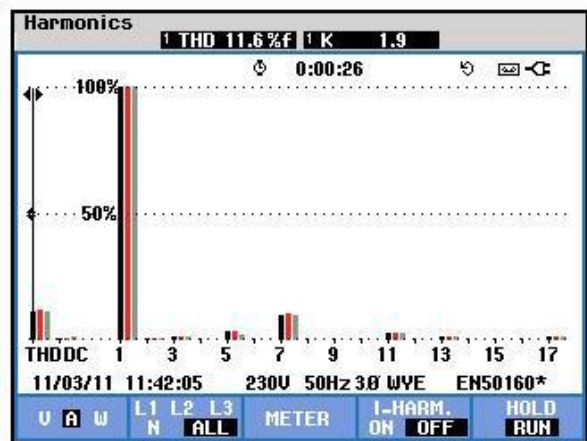

Current harmonics THD = 11.6%

HARMONICS TABLE

Amp	L1	L2	L3	N
THD%f	76.1	78.3	78.3	345.0
H5%f	63.2	66.1	66.3	66.0
H7%f	40.7	40.3	40.2	58.0
H11%f	5.3	5.8	6.7	59.7
H13%f	6.0	5.8	5.2	58.5
H17%f	3.7	4.1	4.5	55.7
H19%f	3.1	3.3	2.8	52.6
H23%f	1.5	1.8	2.0	57.3

Current harmonics THD, H5, H7, H11, H13, H17, H19, H23

HARMONICS TABLE

Amp	L1	L2	L3	N
THD%f	11.6	11.7	11.2	369.9
H5%f	3.8	3.2	2.3	57.4
H7%f	10.2	10.3	10.1	58.3
H11%f	2.9	2.9	2.9	63.8
H13%f	1.6	1.6	1.7	60.1
H17%f	1.4	1.4	1.4	62.2
H19%f	0.7	0.7	0.8	58.5
H23%f	0.7	0.8	0.8	59.0

Current harmonics THD, H5, H7, H11, H13, H17, H19, H23

Example 2: motor drive with built-in DC-link choke

Without ECOsine® filter

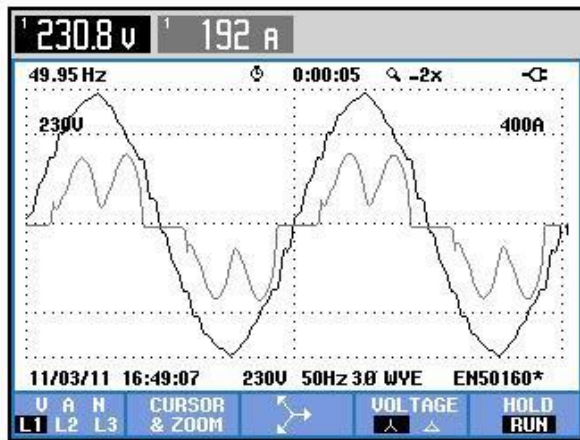

Voltage and current waveforms

With ECOsine® filter

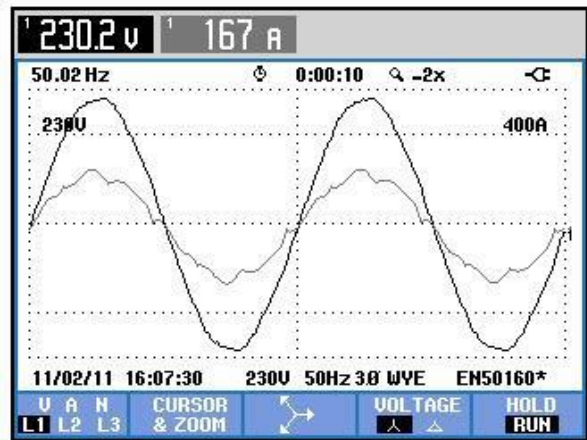

Voltage and current waveforms

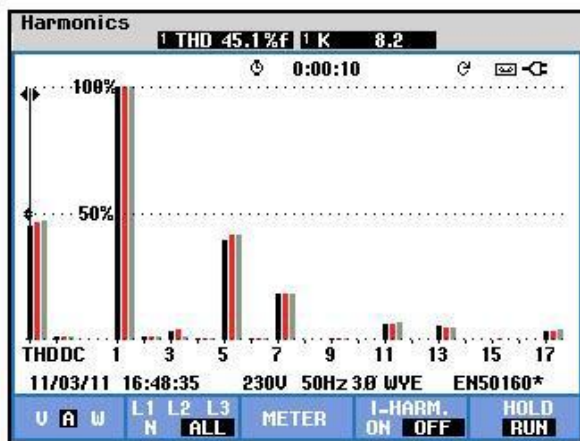

Current harmonics THD = 45.1%

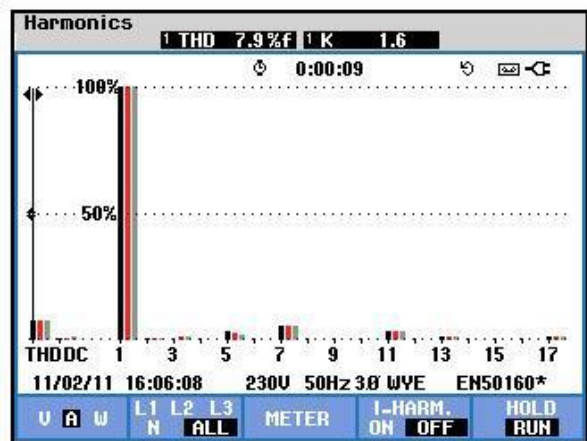

Current Harmonics THD = 7.9%

HARMONICS TABLE

Amp	L1	L2	L3	N
THD%f	46.2	46.8	47.0	327.3
H5%f	40.7	41.6	41.8	60.5
H7%f	18.7	18.4	18.5	56.2
H11%f	6.2	6.4	6.7	57.8
H13%f	5.4	5.1	5.0	55.3
H17%f	3.5	3.7	3.9	52.4
H19%f	3.2	3.2	3.0	49.0
H23%f	1.6	1.9	2.0	53.6

Current harmonics THD, H5, H7, H11, H13, H17, H19, H23

HARMONICS TABLE

Amp	L1	L2	L3	N
THD%f	7.9	8.0	7.7	365.3
H5%f	2.7	2.5	1.6	62.0
H7%f	5.9	6.0	5.9	63.5
H11%f	3.5	3.5	3.6	60.3
H13%f	1.5	1.5	1.6	61.2
H17%f	1.5	1.6	1.6	55.8
H19%f	1.1	1.0	1.1	57.7
H23%f	0.8	0.8	0.8	58.9

Current harmonics THD, H5, H7, H11, H13, H17, H19, H23

4. Filter selection

ECOsine® harmonic filters need to be carefully selected in order to enjoy maximum benefits.

Step 1: supply frequency

Determine, whether the system in question will be operated in a 50Hz or 60Hz electricity grid, and select the corresponding filter family according to the following table:

50Hz grid	Europe, Middle East, parts of Asia, parts of South America	FN 3416, FN3416LV
60Hz grid	North and Central America, parts of Asia, parts of South America	FN 3418, FN3418LV

Note: a 50Hz filter will not provide satisfying harmonics mitigation in a 60Hz grid, and vice versa.

Step 2: supply voltage and configuration

Verify, that the supply voltage and configuration is suitable for standard ECOsine® harmonic filters according to the following table:

50Hz grid	Nominal voltage 380-500VAC $\pm 10\%$	TN, TT, IT configuration
60Hz grid	Nominal voltage 380-480VAC $\pm 10\%$	TN, TT, IT configuration
50Hz grid	Nominal voltage 200-240VAC $\pm 10\%$	TN, TT, IT configuration
60Hz grid	Nominal voltage 200-240VAC $\pm 10\%$	TN, TT, IT configuration

Note: filters for 690V/50Hz or 600V/60Hz are available upon request.

Step 3: real rectifier/drive input power

The individual filter must be selected by the actual rectifier/drive input real power (kW, HP). It is important to select the filter as close as possible to the effective input power of the rectifier/drive.

Note that FN 3416 (50Hz) filters show double ratings in the selection table. Depending upon the grid voltage, the same filter is rated for two different rectifier/drive input real power values. For 380/400/415V lines, the filters have a lower power rating than for 500V systems.

Note that if the rectifier/drive is being operated very close to its rated power, then the filter can be selected by the motor drive's nominal power rating. However, if the drive will be operated e.g. at only 66% of its rated power, then a smaller filter should be selected in order to get maximum harmonics mitigation performance and the optimum in terms of filter cost, size, and weight.

Please refer to the following examples:

Example 1:

Power line rating: 400V, 50Hz

Drive rating: 380-500V, 50-60Hz, 15kW, 22.5A, diode rectifier

Planned rectifier/drive input real power: 15kW (100% of drive rating)

➔ **Recommended filter according to the filter selection table FN 3416: Type FN 3416-32-33**

Example 2:

Power line rating: 500V, 50Hz

Drive rating: 380-500V, 50-60Hz, 15kW, 22.5A, diode rectifier

Planned rectifier/drive input real power: 15kW (100% of drive rating)

➔ **Recommended filter according to the filter selection table FN 3416: Type FN 3416-24-33**

Example 3:

Power line rating: 400V, 50Hz

Drive rating: 380-500V, 50-60Hz, 15kW, 22.5A, diode rectifier

Planned rectifier/drive input real power: 10kW (66% of drive rating)

➔ **Recommended filter according to the filter selection table FN 3416: Type FN 3416-24-33**

Example 4:

Power line rating: 500V, 50Hz

Drive rating: 380-500V, 50-60Hz, 15kW, 22.5A, diode rectifier

Planned rectifier/drive input real power: 10kW (66% of drive rating)

➔ **Recommended filter according to the filter selection table FN 3416: Type FN 3416-16-44**

OVERRATING THE FILTER DOES NEVER MAKE SENSE, BECAUSE OF THE INHERENT LOWER HARMONICS MITIGATION PERFORMANCE AT LIGHT LOAD, AS WELL AS HIGHER PRICE, SIZE, AND WEIGHT.

Please refer to the selection tables on the next page.

Filter selection table FN 3416 (50Hz)

Filter selection table FN3416

Filter*	Rated load power @ 400 VAC / 50 Hz	Rated load power @ 500 VAC / 50 Hz	Power loss** @ 25 °C / 50 Hz	Input/output connections 	Weight [kg]
	[kW]	[kW]			
FN3416-10-44	4	5.5	63	-44	10
FN3416-13-44	5.5	7.5	82	-44	10
FN3416-16-44	7.5	11	105	-44	15
FN3416-24-33	11	15	153	-33	20
FN3416-32-33	15	18.5	294	-33	22
FN3416-38-33	18.5	22	256	-33	25
FN3416-45-33	22	30	306	-33	29
FN3416-60-34	30	37	408	-34	37
FN3416-75-34	37	45	410	-34	43
FN3416-90-35	45	55	493	-35	47
FN3416-110-35	55	75	546	-35	50
FN3416-150-40	75	90	784	-40	86
FN3416-180-40	90	110	817	-40	92
FN3416-210-40	110	132	887	-40	100
FN3416-260-99	132	160	947	-99	125
FN3416-320-99	160	200	988	-99	135

* Filter to be selected by system voltage and load (motor drive) power. Note: the harmonic filter will reduce RMS input current. Therefore, filter selection by current rating, as it is common for EMC/EMI filters, is not recommended.

** Calculated power loss at rated load power.

Filter selection table FN 3418 (60Hz)

Filter selection table FN3418



Filter*	Rated load power @ 460 VAC / 60 Hz	Power loss** @ 25 °C / 60 Hz	Input/output connections 	Weight [kg]
	[HP]			
FN3418-8-44	5	41	-44	10
FN3418-11-44	7.5	81	-44	10
FN3418-15-44	10	72	-44	16
FN3418-21-33	15	152	-33	20
FN3418-28-33	20	214	-33	22
FN3418-35-33	25	277	-33	25
FN3418-41-33	30	289	-33	28
FN3418-53-34	40	383	-34	38
FN3418-65-34	50	393	-34	42
FN3418-80-35	60	493	-35	45
FN3418-105-35	75	514	-35	54
FN3418-130-40	100	741	-40	78
FN3418-160-40	125	832	-40	87
FN3418-190-40	150	873	-40	100
FN3418-240-99	200	876	-99	126
FN3418-310-99	250	984	-99	135

* Filter to be selected by system voltage and load (motor drive) power. Note: the harmonic filter will reduce RMS input current. Therefore, filter selection by current rating, as it is common for EMC/EMI filters, is not suitable.

** Calculated power loss at rated load power.

Filter selection table FN 3416LV (50Hz)

Filter selection table



Filter*	Rated load power @ 220 VAC/50 Hz	Power loss** @ 25 °C/50 Hz	Input/Output connections		Weight
	[kW]	[W]			[kg]
FN 3416LV-10-44	2.5	63	-44		10
FN 3416LV-13-44	3	82	-44		10
FN 3416LV-16-44	4	105	-44		15
FN 3416LV-24-33	5.5	153	-33		20
FN 3416LV-32-33	7.5	294	-33		22
FN 3416LV-38-33	11	256	-33		25
FN 3416LV-45-33	15	306	-33		29
FN 3416LV-60-34	18.5	408	-34		37
FN 3416LV-75-34	22	410	-34		43
FN 3416LV-90-35	26	493	-35		47
FN 3416LV-110-35	30	546	-35		50
FN 3416LV-150-40	37	784	-40		86
FN 3416LV-180-40	45	817	-40		92
FN 3416LV-210-40	55	887	-40		100
FN 3416LV-260-99	75	947		-99	125
FN 3416LV-320-99	90	988		-99	135

* Filter to be selected by system voltage and load (motor drive) power. Note: the harmonic filter will reduce RMS input current.
 Therefore, filter selection by current rating, as it is common for EMC/EMI filters, is not recommended.

** Calculated power loss at rated load power.

Filter selection table FN 3418LV (60Hz)

Filter selection table

Filter*	Rated load power @ 208 VAC/60 Hz	Power loss** @ 25 °C/60 Hz	Input/Output connections		Weight
	[HP]	[W]			[kg]
FN 3418LV-8-44	2.5	41	-44		10
FN 3418LV-11-44	3.5	81	-44		10
FN 3418LV-15-44	5	72	-44		16
FN 3418LV-21-33	7.5	152	-33		20
FN 3418LV-28-33	10	214	-33		22
FN 3418LV-35-33	12	277	-33		25
FN 3418LV-41-33	15	289	-33		28
FN 3418LV-53-34	20	383	-34		38
FN 3418LV-65-34	25	393	-34		42
FN 3418LV-80-35	30	493	-35		45
FN 3418LV-105-35	40	514	-35		54
FN 3418LV-130-40	50	741	-40		78
FN 3418LV-160-40	60	832	-40		87
FN 3418LV-190-40	75	873	-40		100
FN 3418LV-240-99	100	876		-99	126
FN 3418LV-310-99	125	984		-99	135

* Filter to be selected by system voltage and load (motor drive) power. Note: the harmonic filter will reduce RMS input current.
 Therefore, filter selection by current rating, as it is common for EMC/EMI filters, is not recommended.

** Calculated power loss at rated load power.

5. Filter application

ECOsine® filters are designed as “load-applied” filters. In contrary to “bus-applied” filters, which are being installed e.g. at the main power bus of a building, they are specifically designed to be used with either an individual non-linear load, or with a group of non-linear loads.

One advantage of load-applied filtering is the fact that the upstream power (relative to the harmonic filter) is clean. This can be of vital importance when the same power bus supplies both motor drives and sensitive loads. One example could be the elevator drives or HVAC drives in a hospital, where power must be very clean for all the sensitive medical devices. In such a case, it would not be sufficient to use a central harmonic filter at the PCC for IEEE Std 519-2014 compliance purposes.

ECOsine® filters are also suitable for paralleling lower power non-linear loads on a higher power harmonic filter to improve overall system economy. In this case the total expected load power of all connected drives must match the filter.

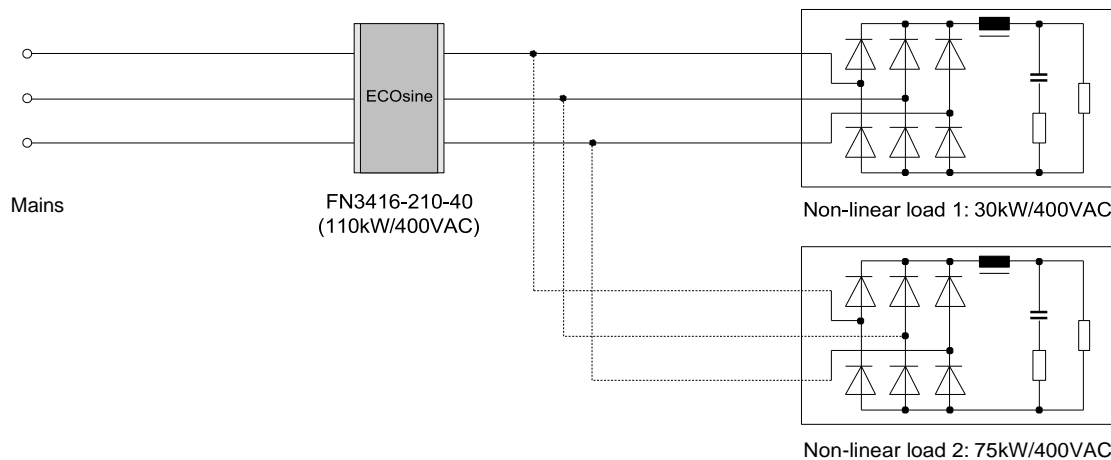

If the expected input power exceeds the rating of the largest available filter, and a custom solution is not desired, then two or more filters can be wired in parallel. In this mode of operation, it is recommended to use filters with equal power ratings to ensure proper current sharing.

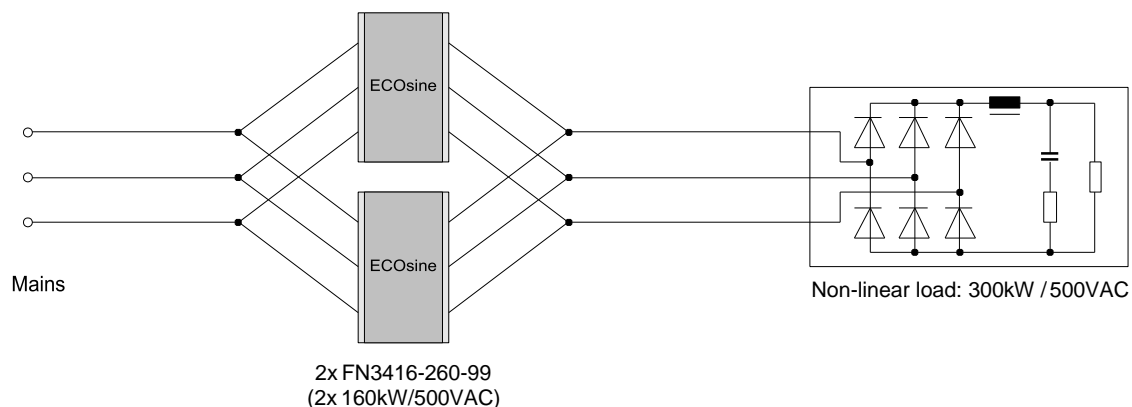

AC line reactors are not required when ECOsine® filters are installed. For a new system, this helps to offset a good portion of the harmonic filter cost. If a harmonic filter is added to a drive with an existing AC line reactor, it is recommended to remove the reactor if possible.

6. Filter installation

Please follow the few simple steps below to ensure a safe and satisfying filter function for many years.

Step 1: Visual inspection

All Schaffner ECOsine® filters have undergone rigorous testing before they left our ISO 9001:2008 certified factory. They are packaged with great care in a sturdy container for international shipment.

However, carefully inspect the shipping container for damage that may have occurred in transit. Then unpack the filter and carefully inspect for any signs of damage. Save the shipping container for future transportation of the filter.

In the case of damage, please file a claim with the freight carrier involved immediately and contact your local Schaffner partner for support. Under no circumstances install and energize a filter with visible transportation damage.

If the filter is not going to be put in service upon receipt, store within the original container in a clean, dry location, free of dust and chemicals.

Step 2: Mounting

ECOsine® load-applied filters are best installed as close as possible to the non-linear load in question. Ideally they are mounted next to the rectifier or motor drive inside the electrical cabinet or control room.

Unlike ECOsine® full performance filters FN3410/11/12/13, all sizes of FN3416/18 and FN3416LV/18LV come in designs for vertical wall mounting.

Note: Filters for vertical wall mounting must not be installed horizontally. Horizontal installation will negatively affect air flow and the life time of the filter.

Important:

In order to ensure sufficient air flow, keep a clearance of at least 150mm above and below the filter to walls or other components.

A 100mm clearance on either side is recommended for the possibility to comfortably open the cover in case of field maintenance.

Additional work to access the device, caused by not respected clear distances, will be accounted separately.

It must be ensured that the environmental temperature is kept below 45°C with appropriate thermal management (e.g. cabinet cooling). Filter operation in warmer environments require temperature derating.

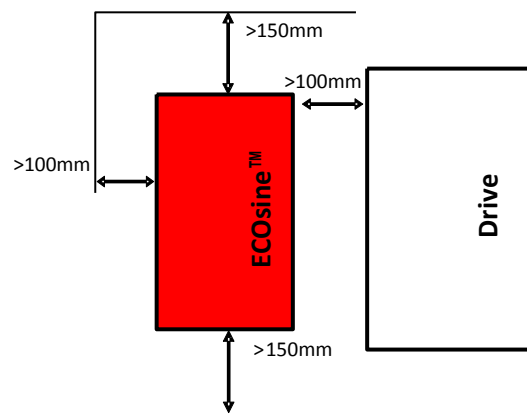

2.1 Drilling pattern for wall mounted filters:

FN 3416/ FN3416LV	FN 3418/ FN3418LV	H	W	D
-10, -13, -16	-8, -11, -15	370	140	M8
-24, -32, -38, -45	-21, -28, -35, -41	435	200	M10
-60, -75	-53, -65	500	225	M10
-90, -110	-80, -105	555	225	M10
-150, -180, -210	-130, -160, -190	665	350	M12
-260, -320	-240, -310			

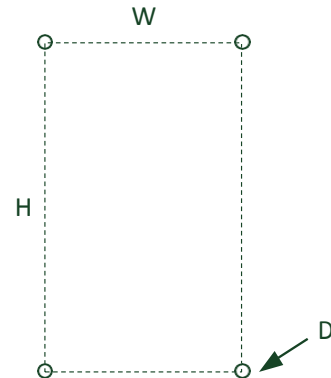

All dimensions in mm; 1 inch = 25.4mm

Note: the numbers (e.g. -10) are in reference to the middle part of the ECOSine part number coding (e.g. FN 3416-10-44)

2.2 Bolt selection: Schaffner recommends zinc coated hex ribbed flange steel bolts. Respect filter weight for appropriate choice of bolts! Head diameters must not exceed these dimensions:

M8: $d \leq 18.2\text{mm}$, M10: $d \leq 21.2\text{mm}$ M12: $d \leq 25\text{mm}$

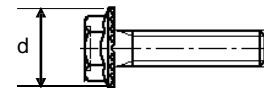

2.3 Filter placement:

1. Set bolts loose into wall, leave 5mm distance from head to wall.
2. Lift filter with appropriate hoist, using lifting eye bolt (attached in package) – smallest types (up to 20kg) may be lifted manually by two persons (no lifting eye bolt applicable).
3. Place filter first onto lower bolts...
4. ...then position it through backplane head openings on upper bolts.
5. Fix bolts with appropriate torque (depending upon the material of the back plane and local standards).

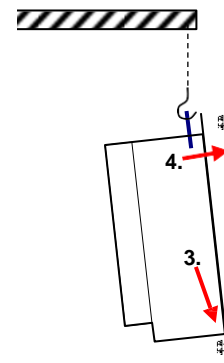

Step 3: Wiring

3.1 Verify safe disconnection of all line side power.

Consult your local safety instructions.



3.2 Safety cover for filters with bus-bar terminals.

The filters with bus-bar terminals (FN3416/FN3416LV-260/320-99, FN 3418/FN3418LV -240/310-99) are equipped with a terminal cover for safety reasons.

Untighten the bolt on the front side to remove the cover.

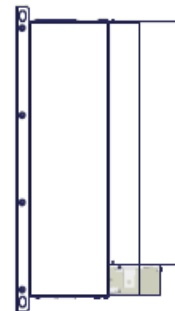

3.3 Connect protective earth (PE) wire to adequate earth potential close to ECOsine® filter.

Use a wire diameter of equal or bigger size as foreseen for line/load side power cables – according to your local codes and safety instructions.

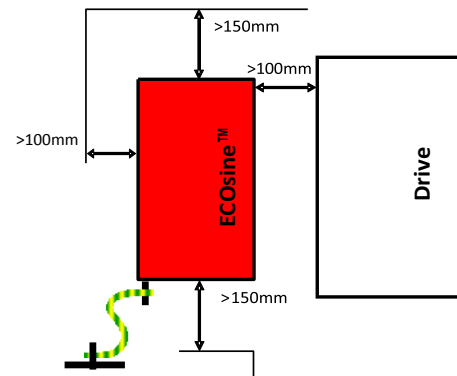

3.4 Connect PE wire to min. one available PE bolt

with appropriate cable lug to threaded stud.

- max. torque M6: 4Nm
- max. torque M8: 10Nm
- max. torque M10: 18Nm
-

3.5 Connect ECOsine® load side terminals L1', L2', L3' to respective motor drive or rectifier inputs.

Last two digits of ECOsine® part number, i.e. FN 3418-65-**34**, indicate terminal type. See table to the right for recommended wire size and torque.

Use stranded copper wire with a temperature rating of 75°C or higher.

Terminal	Wire		Torque Nm
	AWG	mm ²	
-44	8	6	1.0 - 1.2
-33	6	10	1.5 - 1.8
-34	2	25	4.0 - 4.5
-35	1/0	50	7.0 - 8.0
-40	4/0	95	17 - 20
-99	6/0	150	25 - 30

3.6 Connect over-temperature contact

The over-temperature contact is a relay contact, which is open in ALARM state. Its load rating is 250VAC/30VDC/2.5A. It may either be used to remotely disconnect the drive's load via respective input of drive control (check drive manual) or as alarm sensor for system control unit.

AN ENGAGED OVER-TEMPERATURE CONTACT MUST LEAD TO IMMEDIATE LOAD SHUTDOWN AND INVESTIGATION OF THE PROBLEM.

3.7 Connect ECosine® line side terminals L1, L2, L3

to power input protection (current limiting fuses – see below).

3.8 Fuses

ECosine™ filters need external over-current protection for compliance with UL/cUL standard. Fuses and associated fuseholders must be UL listed and rated for 100kA SCCR supplies. The subsequent list shows requested fuse current ratings for UL class J and, where UL compliance is not mandatory, for IEC class gG. The fuse rating is independent of the supply voltage.

ECosine® type	Fuse class J	ECosine® type	Fuse class J	Fuse class gG
FN3418 ...		All FN3416 ...		
<u>FN3418LV ...</u>	<u>rated A</u>	<u>FN3416LV ...</u>	<u>rated A</u>	<u>rated A</u>
-8-44	8	-10-44	10	10
-11-44	10	-13-44	15	10
-15-44	15	-16-44	20	16
-21-33	25	-24-33	25	20
-28-33	30	-32-33	35	35
-35-33	35	-38-33	40	35
-41-33	45	-45-33	50	50
-53-34	60	-60-34	75	63
-65-34	70	-75-34	80	80
-80-35	90	FN 3416-90-35	100	100
-105-35	110	-110-35	150	125
-130-40	150	-150-40	175	160
-160-40	175	-180-40	200	200
-190-40	225	-210-40	250	224
-240-99	300	-260-99	300	250
-310-99	350	-320-99	350	300

A system with multiple ECOsine® filters paralleled for a high power load need each a separate 3-phase line side fuse block, corresponding to the respective filter and according to above table. The drive's application manual may prescribe line-side fuse protection as well, which in this case either corresponds to the sum of the filter fuse ratings or, if lower, would request separate drive fuses at its input.

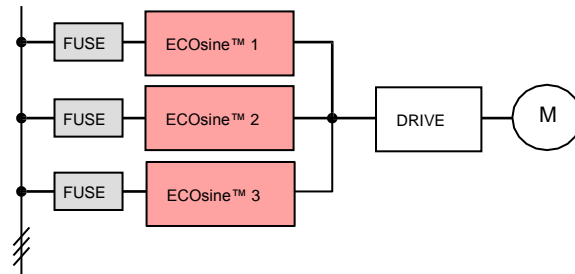

An application, having one ECOsine® filtering harmonics of several drives, requires in any case line side fuse protection of the drives as well as the correct filter protection according to above table.

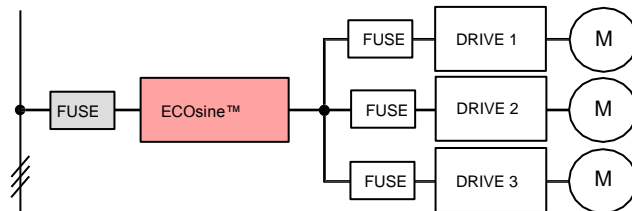

3.9 Safety cover for filters with bus-bar terminals.

Once all filter terminals are properly wired, replace the safety cover by tightening the previously untightened bolt.

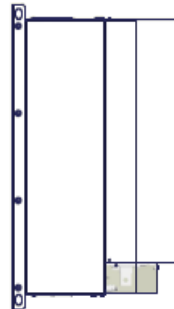

7. Filter maintenance

Schaffner ECOsine® filters are reliable low maintenance products. Many products like power supplies, inverters, or motor drives utilize fans for forced cooling to minimize the size and weight. ECOsine® filters are designed with a similar temperature management concept and therefore, fans may have to be maintained and replaced in certain intervals to sustain the function and value of the product. Fans are 100% field replaceable without the need to uninstall and disconnect the filter.

LINE SIDE POWER MUST BE SWITCHED OFF PRIOR TO REPLACEMENT OF FAN.



Warning:

Power electronic devices like motor drives contain large capacitors which may retain perilous charges for a period of time. Before opening the cabinet or device, disconnect the supply power and let ample time elapse (> 1 minute) for the capacitors to discharge to safe levels. Use a meter to check terminal voltages before touching or handling!

Maintenance considerations:

Schaffner harmonics filters are equipped with long life components that ensure a satisfactory function for many years under normal operating conditions. Any operation under extreme conditions such as over-temperatures, overvoltage situations, polluted environments etc. reduces the life expectancy.

Under normal operating conditions (ambient temp at 45°C) and with the filter permanently at full load, the fan(s) run at 100% duty cycle. This translates roughly to a **10 year** maintenance-free life time.

Nevertheless, it is recommended to check the functionality at least in a **2 year interval**, when a 'normal 100% load' situation is given. More severe operating conditions may require shorter service intervals.

Indications for required fan replacement:	- increased audible noise coming from the fan - after 50,000 hours.
---	--

Power capacitor damage may be caused by severe abnormal supply voltage peaks (i.e. lightning – depending upon system protection), but may only be recognizable through the measurement of line side harmonics distortion. This may be indicated with a modern energy meter or by regular checkup with a distortion analyzer. According to the above considerations, a **2 year inspection interval** is advisable. An inspection should as well be performed after extreme overvoltage situations.

Field replacement of power capacitors is possible, but must be executed by trained Schaffner personnel.

Indications for required capacitor replacement:	- performance loss (THID out of spec) - visible capacitor damage
---	---

Fan specifications:

Supply voltage:	24VDC
Power:	max. 7W
Size:	120x120x25mm, fixation holes 105x105mm, Ø4.3mm
Air flow:	min. 110CFM
Connection:	min. 150mm cable length, TYCO MTA-100 plug, 2 poles (pin 1 = +24VDC)
Recommended types:	SUNON PMD2412PTB3-A NMB-MAT 4710KL-05W-B50

Fan replacement instructions:

- 1 Disconnect line side power.**
Let ample time elapse (> 1 minute) for the capacitors to discharge to safe levels.
Check with voltage meter before proceeding. Consult your local safety instructions.
- 2 Untighten bolts (5x) of fan plate at bottom side of filter.**
- 3 Pull out fan connector plug (1x).**
- 4 Disassemble fan from plate (4 bolts).**
- 5 Mount a new fan with appropriate plug (isolation tube and plug of old fan may be used again; appropriate tool for IDC connection needed). Pay attention to the polarity of the plug.**
- 6 Connect fan to plug socket, re-assemble fan plate.**



Step 2



Step 3



Steps 4, 5

8. Special considerations

8.1 Over-temperature contact and load disconnect

ECOsine® harmonic filters provide basic safety monitoring:

- temperature detection level for each inductive component (over-temperature contact)

This alarm indication requires adequate reaction in order to prevent possible system damage (i.e. cable or cabinet overheating). Either the cabinet safety monitoring unit must make use of the alarm contact, or the contact must directly control a stop function of a connected motor drive (refer to motor drive user manual for applicability).

Important:

Connection and use of the over-temperature contact is required for safe operation. An engaged (open) over-temperature contact must lead to immediate load shutdown and investigation of the problem.

Technical data of over-temperature contact:

Error status:	Switch open
Switching power:	max. 2.5A/250VAC or 30VDC
Technology:	Bi-metal switch (potential-free)
Safety:	UL 2111

Note: The described applications of the monitor contact are proposals. Please respect local and national safety directives.

9. Troubleshooting

Schaffner ECOsine® harmonic filters are high quality products and have undergone rigorous testing and qualification procedures. Every unit runs through a 100% test in our ISO 9001:2008 factories. There are no troubles to be expected if the filter is installed, operated, and maintained as described in this document and within published specifications.

In the unlikely event of a problem, please contact your local Schaffner partner for assistance.

10. FAQ – Frequently asked questions

Q: Why are ECOsine® harmonic filters CE-marked, but Schaffner EMI filters are not?

A: EMI filters and other passive components must not be CE-marked according to the low-voltage directive because they are not sold to the public as an individual device with an independent function. They are usually part of equipment, which in turn has to be CE-marked as a whole. This is different with e.g. a transformer or a harmonic filter. ECOsine® can be sold as an individual aftermarket product that will not necessarily be built into another CE-conform piece of equipment. As a “stand-alone unit”, it must be CE-marked in order to be distributed throughout Europe.

Q: Can ECOsine® filters be used for a single-phase load or just be connected to two phases?

A: This mode of operation is not possible. ECOsine® filters are optimized for balanced three-phase power systems with six-pulse rectifier front ends and their performance depends upon voltage distortion and phase unbalance. Schaffner is experienced in custom harmonic filter design and can potentially come up with a single-phase solution to your requirement.

Q: How are ECOsine® harmonic filters contributing to financial savings? Are they reducing my electricity bill?

A: ECOsine® harmonic filters help to save long term system operating cost and help to avoid expensive system/production downtime. There are two different aspects to answer this question:

1. Most likely, the installation of ECOsine® filters will not result in a lower electricity bill.

ECOsine® harmonic filters substantially reduce reactive current and thus reactive power in the system. However, most utility companies invoice only the consumption of real power, which will not be changed with the installation of ECOsine™. Some utilities may issue penalties for consumers with low power factor (usually <0.9). Low power factor can be caused by phase shift of the fundamental current (low cos phi) and/or by harmonics of the current (high THID) as it is described by the following formula:

$$PF = \frac{\cos \varphi}{\sqrt{1 + THD^2}}$$

For nonlinear loads (like six-pulse rectifiers) value of cos phi is high (close to 1) and the main reason for a reduced power factor is a high value of THID. The installation of ECOsine™ filters would increase the power factor and help to avoid utility penalties, i.e. get into a less expensive rate class. These penalty schemes are different from country to country and from utility company to utility company.

2. Electric systems with significant non-linear loads have high levels of harmonic current distortion and consequently also bad voltage quality. Both can have significant negative effects, such as:

Transformers

- Increased audible noise
- Increase in copper losses (due to current harmonics)
- Increase in iron losses (due to voltage harmonics)

Power installation with capacitive power factor compensators

- Risk of resonance and resulting damage of capacitor banks

Power cables

- Increased heating
- Risk of insulation failure if involved in system resonance

Motors and Generators

- Increased heating due to iron and copper losses at the harmonic frequencies (performance reduced to 90%)
- Higher audible noise
- Refusal to start smoothly (cogging)
- Very high slip in induction motors (crawling)
- Potential of mechanical oscillations in a turbine-generator or motor-load systems
- Pulsating or reduced torques

Capacitors

- Increased heating and voltage stress
- Reduced capacitors life

Electronic Equipment

- Wrong operation of equipment dependent upon accurate determination of the line voltage wave shape (e.g. zero crossing)
- Problems caused by transmission of ac supply harmonics (via power supply or magnetic coupling) into equipment components
- Erratic (sometimes subtle) malfunctions of computers, programmable controllers, medical instruments etc. (in some cases, having very serious consequences)

Metering (watt-hour meters)

- Possible erroneous operation with both positive and negative errors (distortion must be severe >20%)

Switchgear and Relaying

- Increased heating and thus reduced steady-state current carrying capability
- Fuses suffer derating
- Complete definition of relay response impossible
- Older circuit breakers (responding to peak currents) may cause nuisance tripping

Communication Equipment

- Telephone interferences (audible harmonic frequencies)

ECOsine® harmonic filters substantially reduce harmonic currents and therefore basically convert a non-linear load into a linear load. This eliminates the risk for most of the above problems. Lower harmonic currents help to relieve the entire electrical installation from excessive loading and heating, allow more consumers to be powered by the same (existing) installation, and help to postpone expensive electrical system upgrades when retrofitting additional non-linear consumers. ECOsine® filters also reduce the risk of harmonics-related system downtimes which can have tremendous financial consequences e.g. in a semiconductor manufacturing line or a banking center. Last but not least, lower harmonic currents cause less harmonic voltages when flowing through system impedances, so other sensitive consumers (e.g. medical devices) connected to the same branch of the electrical system are not compromised in their functionality.

→ So in essence, the annual savings enabled by ECOsine® harmonic filters are first and foremost the avoided potential expenses thanks to lack of harmonics.

Q: How much cooling air capacity should be planned for the integration of ECOsine® filters into a cabinet?

A: This value, defined as CFM (cubic feet per minute; 1CFM = 1.7m³/h) depends upon filter model and power rating. Please refer to the following table:

FN 3416 (400-500V/50Hz)	FN 3418 (480V/60Hz)	Air capacity needed
FN 3416LV (200-240V/50Hz)	FN 3416 (200-240V/60Hz)	
-10, -13, -16	-8, -11, -15	No fan
-24, -32, -38, -45 -60, -75 -90, -110	-21 -28, -35, -41 -53, -65 -80, -105	110CFM
-150, -180, -210	-130, -160, -190	220CFM
-260, -320	-240, -310	330CFM

11. Custom design input form

There may be occasions where ECOsine® standard filters are not suitable for the job at hand. Schaffner is very experienced in the design and manufacture of custom filters based on the existing modular ECOsine® platform and can potentially come up with an alternative design proposal for you.

Custom harmonic filters include (but are not limited to) solutions for higher power ratings, higher voltage ratings, different performance levels, or special mechanical designs.

Please use the following table to gather essential technical information prior to contacting your local Schaffner partner.

Application incl. power system:		
Types of non-linear loads:		
Types of rectifiers involved:		
System block schematic:		
Current harmonic spectrum:		
Required harmonics reduction (THID, TDD, standard):		
Expected total load real power:		[kW], [HP]
Expected total input current:		[A]
System voltage:		[VAC]
System frequency:		[Hz]
Efficiency:		[%]
Overload capability:		[%]
Max. capacitive current:		[%], [A]
Ambient temperature:		[°C]
Expected life time:		[h]
Mechanical requirements:		
Terminals:		
Safety approvals:		
Monitoring functionality:		
Other special requirements:		

Please also consider FN3410/11/12/13 ECOsine® full performance filters (THID <5%) for your application!

Appendix I: International standards

The use of non-linear loads with six-pulse rectifiers has grown rapidly in recent years, to the point where this type of load represents more than 50% of western world power system load. Harmonic currents and the resulting voltage distortions can have devastating effects on power distribution systems and connected equipment. Therefore, national and international standards for harmonic distortions (and other Power Quality problems) are needed.

In the following, a brief overview of some important international standards/recommendations are provided. For full details, please obtain the required standards directly from IEEE, IEC, and other organizations.

I. Engineering recommendation G5/4-1

Definitions:

Non-linear load or equipment	A load or equipment that draws a non-sinusoidal current when energized by a sinusoidal voltage.
Aggregate load	Non-linear load equal to the sum of the individual non-linear equipment ratings.
Fault level	A value expressed in MVA of the symmetrical short-circuit power at a point in the supply system. It is defined as the product of the symmetrical short-circuit current (I_{sc}) and the nominal system voltage (U_{ph-ph} or U_{ph-n}): $F = I_{sc} \cdot U_{ph-ph} \cdot 3 = I_{sc} \cdot U_{ph-n} \cdot 3$
Harmonic current (I_h)	The RMS value of a harmonic current, of order h , expressed in amperes.
Harmonic distortion	The cyclic departure of a waveform from the sinusoidal shape. This can be described by the addition of one or more harmonics to the fundamental.
Point of common coupling (PCC)	The point in the public supply system, electrically nearest to a customer's installation, at which other customers' loads are, or may be, connected.
Total harmonic voltage distortion (THD)	$THD = \sqrt{\frac{\sum_{h=2}^{h=50} V_h^2}{V_1^2}}$

G5/4-1 planning levels for harmonic voltages:

Table 2: Planning Levels for Harmonic Voltages in 400V Systems

Odd harmonics (Non-multiple of 3)		Odd harmonics (Multiple of 3)		Even harmonics	
Order 'h'	Harmonic voltage (%)	Order 'h'	Harmonic voltage (%)	Order 'h'	Harmonic voltage (%)
5	4.0	3	4.0	2	1.6
7	4.0	9	1.2	4	1.0
11	3.0	15	0.3	6	0.5
13	2.5	21	0.2	8	0.4
17	1.6	>21	0.2	10	0.4
19	1.2			12	0.2
23	1.2			>12	0.2
25	0.7				
>25	$0.2 + 0.5^{(25/h)}$				

The Total Harmonic Distortion (THD) level is 5%.

G5/4-1 current harmonic limits for loads rated >16A per phase:

Table 7: Stage 1 Maximum Permissible Harmonic Current Emissions in Amperes RMS for Aggregate Loads and Equipment Rated >16A per phase

Harmonic order, h	Emission current, I _h	Harmonic order, h	Emission current, I _h	Harmonic order, h	Emission current, I _h	Harmonic order, h	Emission current, I _h
2	28.9	15	1.4	28	1.0	41	1.8
3	48.1	16	1.8	29	3.1	42	0.3
4	9.0	17	13.6	30	0.5	43	1.6
5	28.9	18	0.8	31	2.8	44	0.7
6	3.0	19	9.1	32	0.9	45	0.3
7	41.2	20	1.4	33	0.4	46	0.6
8	7.2	21	0.7	34	0.8	47	1.4
9	9.6	22	1.3	35	2.3	48	0.3
10	5.8	23	7.5	36	0.4	49	1.3
11	39.4	24	0.6	37	2.1	50	0.6
12	1.2	25	4.0	38	0.8		
13	27.8	26	1.1	39	0.4		
14	2.1	27	0.5	40	0.7		

These limits are based on a typical fault level of 10 MVA; see Table 9 and Application Guide ETR 122.

II. International standard EN 61000-3-12

This standard applies to equipment intended to be connected to low-voltage systems interfacing with the public supply at the low-voltage level. It does not apply to equipment intended to be connected only to private low-voltage systems interfacing with the public supply only at the medium- or high-voltage level.

Definitions:

Total harmonic distortion (THD)

Ratio of the r.m.s. value of the harmonics (harmonic currents I_n of the order n) to the r.m.s. value of the fundamental:

$$THD = \frac{\sqrt{\sum_{n=2}^{40} I_n^2}}{I_1}$$

Partial weighted harmonic distortion (PWHD)

Ratio of the r.m.s. value of a selected group of higher order harmonics (in this International Standard beginning from the fourteenth harmonic), weighted with the harmonic order n , to the r.m.s. value of the fundamental:

$$PWHD = \sqrt{\sum_{n=14}^{40} n \cdot \left(\frac{I_n}{I_1}\right)^2}$$

Reference fundamental current (I_1)

r.m.s. value of the fundamental component of the rated line current I_{equ} of the equipment. The reference fundamental current I_1 , shall be either measured, or calculated as follows:

$$I_1 = \frac{I_{equ}}{\sqrt{1 + THD^2}}$$

Total harmonic current (THC)

The total r.m.s. value of the harmonic current components of orders 2 to 40:

$$THC = \sqrt{\sum_{n=2}^{40} I_n^2}$$

Point of common coupling (PCC)

The point in the public system which is closest to the customer concerned, and to which other customers are, or may be, connected.

Short circuit power (S_{sc})

Value of the three-phase short-circuit power calculated from the nominal interphase system voltage $U_{nominal}$ and the line impedance Z of the system at the PCC:

$$S_{sc} = U_{nom}^2 / Z$$

where Z is the system impedance at the power frequency.

Rated apparent power of the equipment (S_{equ})

Value calculated from the rated line current I_{equ} of the piece of equipment stated by:

$$S_{equ} = 3 \cdot U_i \cdot I_{equ}$$

Short circuit ratio (R_{sce})

Characteristic value of a piece of equipment defined as follows:

$$R_{sce} = S_{sc} / S_{equ}$$

EN 61000-3-12 current harmonic limits:

Table 3 – Current emission limits for balanced three-phase equipment

Minimal R_{sce}	Admissible individual harmonic current I_n/I_1^a %				Admissible harmonic current distortion factors %	
	I_5	I_7	I_{11}	I_{13}	<i>THD</i>	<i>PWHD</i>
33	10,7	7,2	3,1	2	13	22
66	14	9	5	3	16	25
120	19	12	7	4	22	28
250	31	20	12	7	37	38
≥350	40	25	15	10	48	46

NOTE 1 The relative values of even harmonics up to order 12 must not exceed 16/n %. Even harmonics above order 12 are taken into account in *THD* and *PWHD* in the same way as odd order harmonics.

NOTE 2 Linear interpolation between successive R_{sce} values is permitted. See also Annex B.

^a I_1 = reference fundamental current; I_n = harmonic current component.

Table 4 – Current emission limits for balanced three-phase equipment under specified conditions

Minimal R_{sce}	Admissible individual harmonic current I_n/I_1^a %				Admissible harmonic current distortion factors %	
	I_5	I_7	I_{11}	I_{13}	<i>THD</i>	<i>PWHD</i>
33	10,7	7,2	3,1	2	13	22
≥120	40	25	15	10	48	46

NOTE 1 The relative values of even harmonics up to order 12 must not exceed 16/n %. Even harmonics above order 12 are taken into account in *THD* and *PWHD* in the same way as odd order harmonics.

NOTE 2 Linear interpolation between successive R_{sce} values is permitted. See also Annex B.

^a I_1 = reference fundamental current; I_n = harmonic current component.

Conditions to use Table 4:

- The phase angle of the 5th harmonic current related to the fundamental phase voltage is in the range of 90° to 150°.

Note: This condition is normally fulfilled by equipment with an uncontrolled rectifier bridge and capacitive filter, including a 3% AC or 4% DC reactor.
- The design of the equipment is such that the phase angle of the 5th harmonic current has no preferential value over time and can take any value in the whole interval (0°...360°).

Note: This condition is normally fulfilled by converters with fully controlled thyristor bridges.
- The 5th and 7th harmonic currents are each less than 5% of the reference fundamental current.

Interpolation of current harmonic limits:

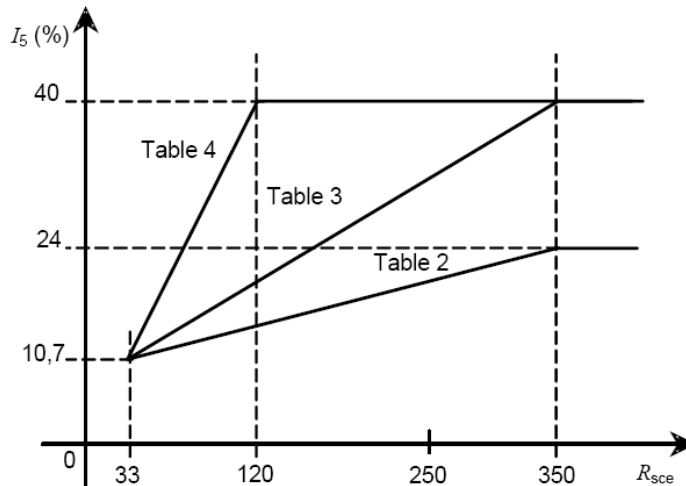

Figure A.1 – Limits of the 5th harmonic current as functions of R_{sce}

Product documentation according to EN 61000-3-12:

For equipment complying with the harmonic current emission limits corresponding to $R_{sce} = 33$, the manufacturer shall state in his instruction manual or literature:

"Equipment complying with IEC 61000-3-12"

For equipment not complying with the harmonic currents emission limits corresponding to $R_{sce} = 33$, the manufacturer shall:

- determine the minimum value of R_{sce} for which the limits given in Table 3 or 4 are not exceeded,
- declare the value of the short-circuit power S_{sc} corresponding to this minimal value of R_{sce} in the equipment instruction manual
- and instruct the user to determine, in consultation with the distribution network operator, that the equipment is connected only to a supply of that S_{sc} value or more. For that purpose, the statement in the instruction manual shall be:

"This equipment complies with IEC 61000-3-12 provided that the short-circuit power S_{sc} is greater than or equal to xx at the interface point between the user's supply and the public system. It is the responsibility of the installer or user of the equipment to ensure, by consultation with the distribution network operator if necessary, that the equipment is connected only to a supply with a short-circuit power S_{sc} greater than or equal to xx."

Where xx is the value of S_{sc} corresponding to the minimum value of R_{sce} for which the limits given in Table 3 or 4 are not exceeded.

III. IEEE Std 519

Table 10-3 lists the harmonic current limits based on the size of the load with respect to the size of the power system to which the load is connected. The ratio I_{sc}/I_L is the ratio of the short-circuit available at the point of common coupling (PCC), to the maximum fundamental load current.

IEEE Std 519-1992 also introduces the total demand distortion (TDD), the harmonic current distortion in % of maximum demand load current (15 or 30min demand).

The limits listed in Tables 10-3 (respectively, Table 2 pag7 in the last release IEEE-519/2014, the table is unchanged) should be used as system design values for the worst case for normal operation (conditions lasting longer than one hour). For shorter periods, during start-ups or unusual conditions, the limits may be exceeded by 50%.

Table 10-3: current distortion limits for general distribution systems (120V through 69000V):

Maximum Harmonic Current Distortion in Percent of I_L						
Individual Harmonic Order (Odd Harmonics)						
I_{sc}/I_L	<11	$11 \leq h < 17$	$17 \leq h < 23$	$23 \leq h < 35$	$35 \leq h$	TDD
<20*	4.0	2.0	1.5	0.6	0.3	5.0
20<50	7.0	3.5	2.5	1.0	0.5	8.0
50<100	10.0	4.5	4.0	1.5	0.7	12.0
100<1000	12.0	5.5	5.0	2.0	1.0	15.0
>1000	15.0	7.0	6.0	2.5	1.4	20.0

Even harmonics are limited to 25% of the odd harmonic limits above.

Current distortions that result in a dc offset, e.g., half-wave converters, are not allowed.

* All power generation equipment is limited to these values of current distortion, regardless of actual I_{sc}/I_L .

where
 I_{sc} = maximum short-circuit current at PCC.
 I_L = maximum demand load current (fundamental frequency component) at PCC.

Other standards:

ECOsine® harmonic filters are suitable to help fulfill the most stringent requirements of IEEE Std 519-1992 or EN 61000-3-12. They also fulfill the requirements of other standards, like e.g. EN 12015 for elevators and escalators. However, because of different/relaxed limits, simpler filters may be sufficient for the job. Schaffner has already designed many engineered harmonic filters for relaxed requirements and may be able to quickly offer you a custom product that perfectly matches the requirements of an application.

Appendix II: Declaration of conformity

Declaration of Conformity



manufacturer: Schaffner EMV AG
Nordstrasse 11
CH-4542 Luterbach
Switzerland

declares, under the sole responsibility, that the following

products: ECOsine™ FN3410 range
ECOsine™ FN3411 range
ECOsine™ FN3412 range
ECOsine™ FN3413 range
ECOsine™ FN3416 range
ECOsine™ FN3418 range

options: all

are in conformity with the following directives and standards:

directives: Low voltage directive 2006/95/EC
EMC directive 2004/108/EC

standards: EN 50178: Electronic equipment for use in power installations
EN 61000-6-2: EMC immunity for industrial environments

ECOsine™ FN3410 to FN3418 filters are passive harmonic filters designed for the operation on the input (grid) side of power electronic equipment with 6-pulse diode or SCR rectifier front ends in balanced three-phase power systems, like typically used in AC or DC motor drives and high power DC supplies.

The installation instructions are integrated part of the product. The product shall exclusively be used in the above-mentioned applications according to the installation instruction. The validity of this declaration expires, if the products are modified or improperly applied.

We certify the compliance of the products and options with the mentioned directives and standards.

Luterbach, 02.08.2011

Schaffner EMV AG

Alexander Hagemann
CEO

Fabian Beck,
VP-Research & Development