

# Multi-stage High Performance AC/DC EMI Filter



- Rated currents from 1 to 16 A
- High differential and common-mode attenuation
- Good low frequency attenuation
- Optional medical versions (B type)
- Optional safety versions (A type)



### Performance indicators

Attenuation performance



### Approvals & Compliances



### Features and Benefits

- FN 2080 two-stage filters are designed for easy and fast chassis mounting
- FN 2080 B versions without capacitors to earth comply to 1MOP for ME (medical equipment) acc. IEC 60601-1
- FN 2080 A version with low capacitance to earth for safety critical applications with necessity for low leakage currents
- All filters provide a high conducted attenuation performance, based on chokes with high saturation resistance and excellent thermal behavior
- FN 2080 two-stage filters are designed with good low frequency attenuation
- FN 2080 filters are also available as single-stage filters
- FN 2080 filters are also available with two common mode choke configuration (FN 2070 series)
- Various terminal options allow you to select the desired connection style

## Technical Specifications

<b>Rated voltage*</b>	250 VAC, 50/60 Hz; 250 VDC
<b>Operating frequency</b>	DC to 400 Hz
<b>Rated currents</b>	1 to 16 A @ 40°C max
<b>High potential test voltage</b>	P → PE 2000 VAC for 2 sec P → PE 2500 VAC for 2 sec (B types) P → N 1100 VDC for 2 sec
<b>Temperature range (operation and storage)</b>	-25°C to +100°C (25/100/21)**
<b>Certified to</b>	UL 1283, CSA 22.2 No. 8 1986, IEC/EN 60939 (applies to AC and DC applications)
<b>Flammability corresponding to</b>	Laces for -07 version: UL 94 VW-1 Terminal plastic for -06/-08 version: UL 94 V-0 Grommet for -07 version: UL 94 V-0
<b>Design corresponding to</b>	UL 1283, CSA 22.2 No. 8 1986, IEC/EN 60939
<b>Overvoltage category</b>	II acc. IEC 60664-1
<b>Pollution degree</b>	2 acc. IEC 60664-1
<b>Altitude</b>	2000m (above derating applies)**
<b>MTBF @ 40°C/230 V (Mil-HB-217F)</b>	1,650,000 hours 1,700,000 hours (B types)

\* maximum RMS operating voltage at rated frequency or the maximum DC operating voltage  
 \*\* for dedicated requests exceeding this specification (e.g. -40 °C or higher altitude) please contact your local Schaffner Sales office







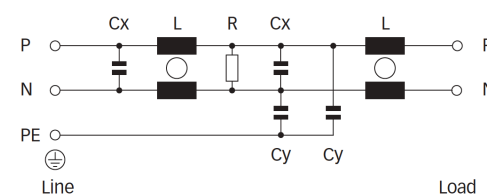













## Typical Applications

- Electrical and electronic equipment
- Lighting applications (due to high differential mode inductance)
- Consumer goods
- Household equipment
- Building automation
- Industrial applications
- Machinery
- Medical equipment
- Electronic data processing equipment
- Office automation and datacom equipment
- Various noisy applications requiring good filter performance

### Typical electrical schematic



### Filter Selection Table

Filter*	Buy	Rated current @ 40°C (25°C)	Leakage current** @ 250 VAC/50 Hz (@ 120 VAC/60 Hz)	Power Loss @25°C/DC	Inductance***		Capacitance***		Resistance*** R	Input/Output connections			Weight [g]
					L	L1	Cx	Cy					
		[A]	[mA]	[W]	[mH]	[µH]	[µF]	[nF]	[kΩ]				
FN2080-1-..		1 (1.2)	0.66 (0.38)	2.6	22	490	0.33	4.7	1000	-06	-07		200
FN2080-3-..		3 (3.5)	0.66 (0.38)	3.7	9.8	160	0.47	4.7	470	-06	-07		270
FN2080-6-..		6 (6.9)	0.66 (0.38)	5.7	7.8	110	1	4.7	220	-06	-07		470
FN2080-10-..		10 (11.5)	0.66 (0.38)	8.6	4.5	60	1	4.7	220	-06	-07	-08	750
FN2080-12-..		12 (13.8)	0.66 (0.38)	12.3	3.25	50	1	4.7	220	-06	-07	-08	750
FN2080-16-..		16 (18.4)	0.66 (0.38)	9.0	2.8	43	1	4.7	220	-06	-07	-08	1020
FN2080A-1-..		1 (1.2)	0.07 (0.04)	2.6	22	490	0.33	0.47	1000	-06	-07		200
FN2080A-3-..		3 (3.5)	0.07 (0.04)	3.7	9.8	160	0.47	0.47	470	-06	-07		270
FN2080A-6-..		6 (6.9)	0.07 (0.04)	5.7	7.8	110	1	0.47	220	-06	-07		470
FN2080A-10-..		10 (11.5)	0.07 (0.04)	8.6	4.5	60	1	0.47	220	-06	-07	-08	750
FN2080A-12-..		12 (13.8)	0.07 (0.04)	12.3	3.25	50	1	0.47	220	-06	-07	-08	750
FN2080A-16-..		16 (18.4)	0.07 (0.04)	9.0	2.8	43	1	0.47	220	-06	-07	-08	1020
FN2080B-1-..		1 (1.2)	0.00	2.6	22	490	0.33		1000	-06	-07		200
FN2080B-3-..		3 (3.5)	0.00	3.7	9.8	160	0.47		470	-06	-07		270
FN2080B-6-..		6 (6.9)	0.00	5.7	7.8	110	1		220	-06	-07		470
FN2080B-10-..		10 (11.5)	0.00	8.6	4.5	60	1		220	-06	-07	-08	750
FN2080B-12-..		12 (13.8)	0.00	12.3	3.25	50	1		220	-06	-07	-08	750
FN2080B-16-..		16 (18.4)	0.00	9.0	2.8	43	1		220	-06	-07	-08	1020

\* To compile a complete part number, please replace the .. with the required I/O connection style (e.g. FN 2080-16-08, FN 2080B-10-06).

\*\* Maximum leakage under usual AC operating conditions (acc. IEC60939-3). Note: if the neutral line is interrupted, worst case leakage could reach twice this level.

\*\*\* Tolerances apply: Inductance: -30/+50%, Capacitance: ±20%, Resistance: ±10%

**Product selector**

FN 2080 x -xx-yy

06	Faston 6.3 × 0.8 mm (spade/soldering)
07	Wire leads
08	Studs (M4 screws)
1 to 16	Rated current
Blank	Standard version
A	Safety version
B	Medical version

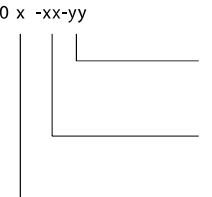

Example:

**FN2080A-10-06**

- A: Safety version (A)
- 10 Ampère current
- 06: fast-on terminals

### Distribution Inventory

Up-to-date inventory levels for global distributors is available at

<https://products.schaffner.com/stock>

or via the QR code printed on the right side



## Typical Filter Attenuation

Per CISPR 17; DM=50 Ω/50 Ω sym; CM=50 Ω/50 Ω asym;

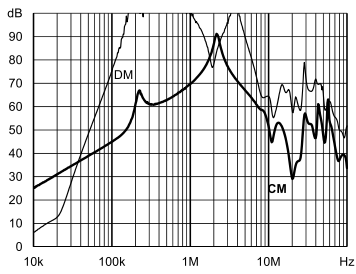

1A: Standard type

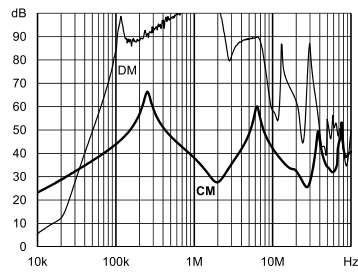

A type

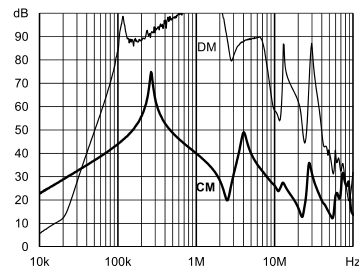

B type

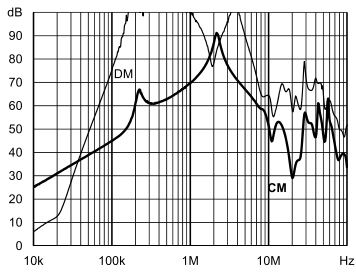

3A: Standard type

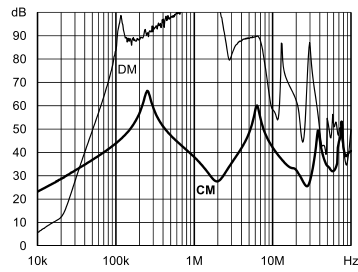

A type

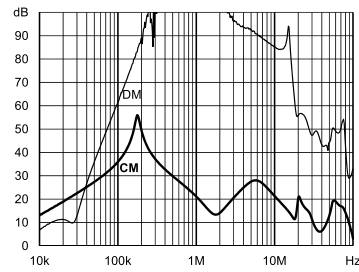

B type

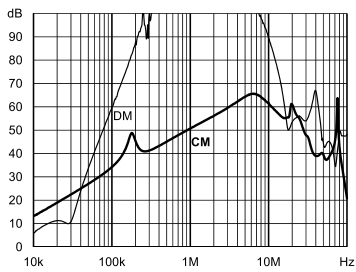

6A: Standard type

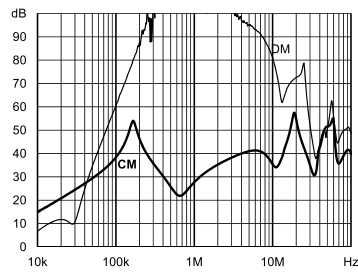

A type

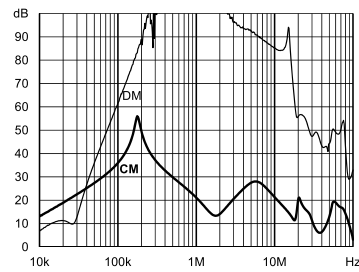

B type

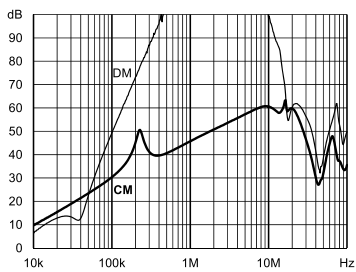

10A: Standard type

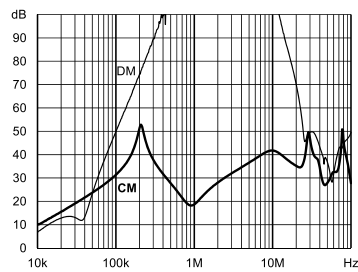

A type

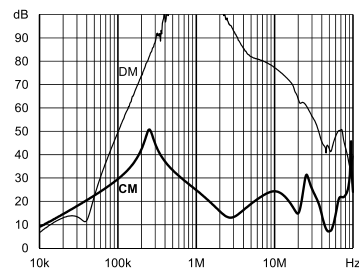

B type

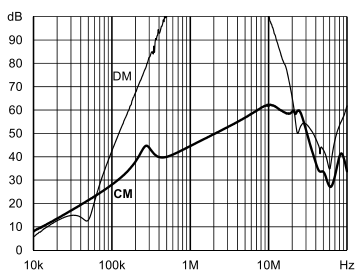

12A: Standard type

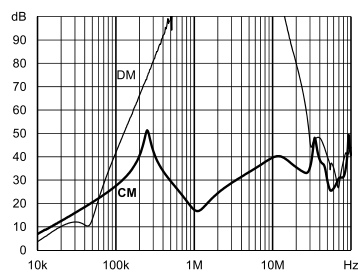

A type

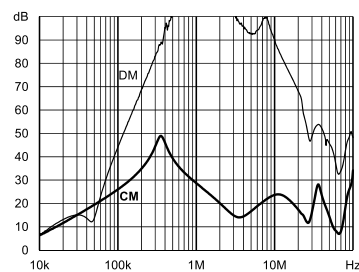

B type

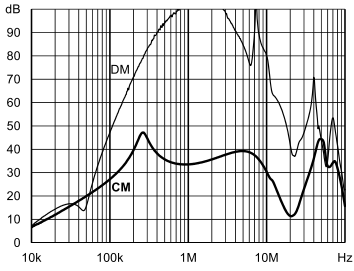

16 A: Standard type

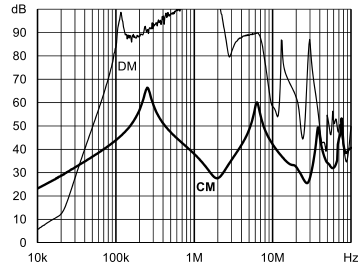

A type

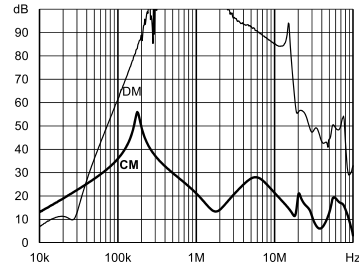

B type

**Mechanical Data**

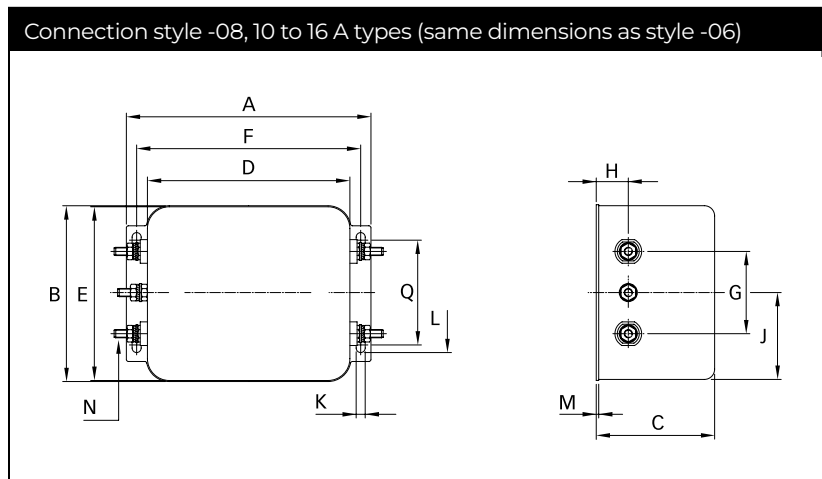
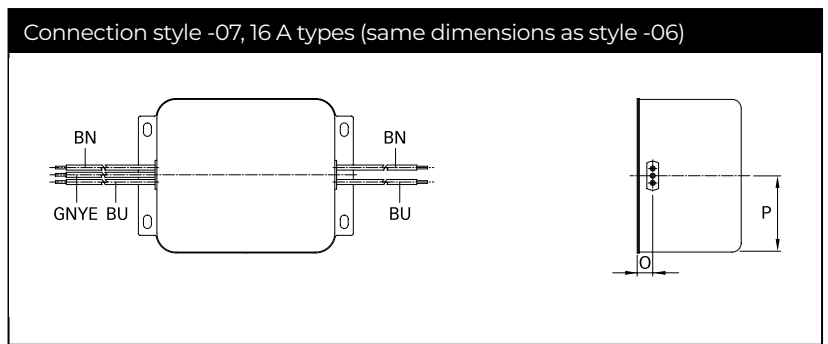
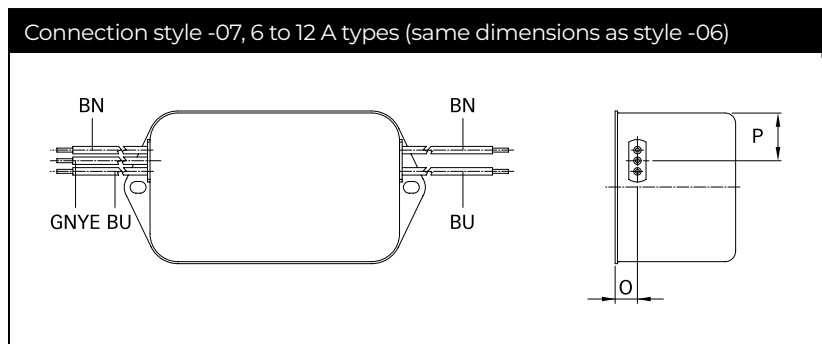
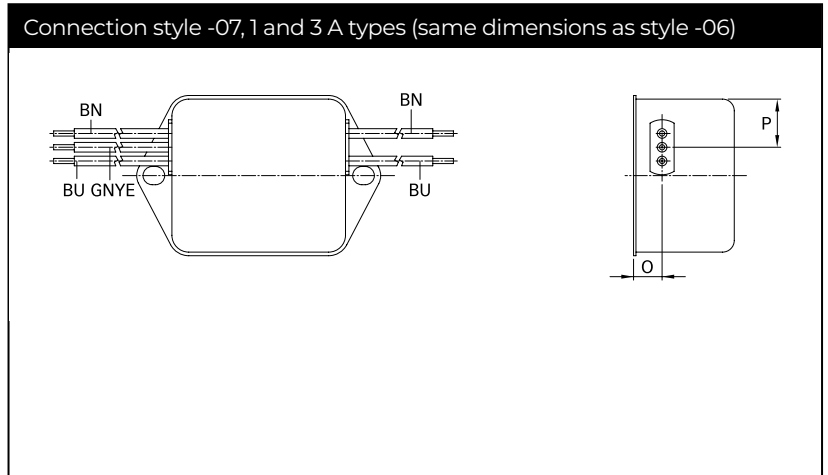
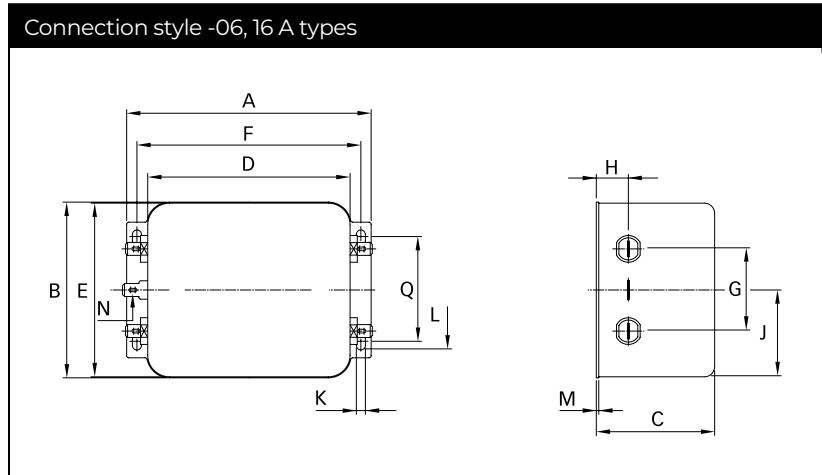
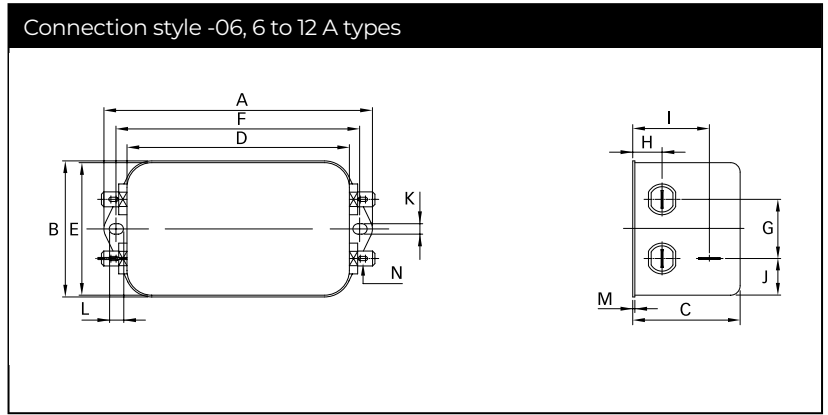
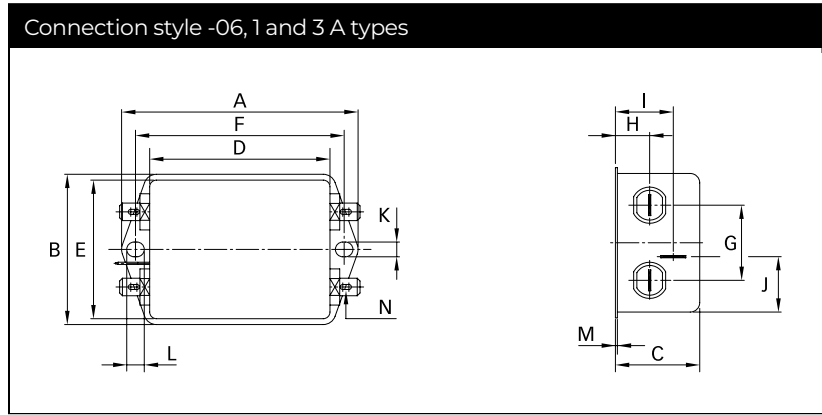

## Dimensions

	1 A	3 A	6 A	10 A	12 A	16 A	Tolerances
<b>A</b>	85	85	113.5 ±1	156 ±1	156 ±1	119 ±1	±0.5
<b>B</b>	54	54	57.5 ±1	57.5 ±1	57.5 ±1	85.5 ±1	±0.5
<b>C</b>	30.3	40.3	45.4 ±1	45.4 ±1	45.4 ±1	57.6 ±1	±0.5
<b>D</b>	64.8	64.8	94 ±1	130.5 ±1	130.5 ±1	98.5 ±1	±0.5
<b>E</b>	49.8	49.8	56	56	56	84.5	±0.5
<b>F</b>	75	75	103	143	143	109	±0.3
<b>G</b>	27	27	25	25	25	40	±0.2
<b>H</b>	12.3	12.3	12.4	12.4	12.4	15.6	±0.5
<b>I</b>	20.8	29.8	32.4	32.5	32.5		±0.5
<b>J</b>	19.9	11.4	15.5	15.5	15.5	42.25	±0.5
<b>K</b>	5.3	5.3	4.4	5.3	5.3	4.4	
<b>L</b>	6.3	6.3	6	6	6	7.4	
<b>M</b>	0.7	0.7	1	1	1	1.2	± 0.3
<b>Connection style -06</b>							
<b>N</b>	6.3 x 0.8	6.3 x 0.8	6.3 x 0.8	6.3 x 0.8	6.3 x 0.8	6.3 x 0.8	
<b>Connection style -07</b>							
<b>O</b>	8.3	8.3	8.4	8.4	8.4	8.6	±0.5
<b>P</b>	14.9	14.9	18	18	18	42.25	±0.5
<b>AWG type wire</b>	AWG 20	AWG 20	AWG 18	AWG 18	AWG 16	AWG 16	
<b>Wire length</b>	140	140	140	140	140	140	+5
<b>Connection style -08</b>							
<b>N</b>				M4	M4	M4	
<b>Q</b>						51	±0.2
<b>Recommended torque (Nm)</b>				1.2 - 1.3	1.2 - 1.3	1.2 - 1.3	
<b>Earth terminal</b>				1.5 - 1.7	1.5 - 1.7	1.5 - 1.7	

All dimensions in mm; 1 inch = 25.4 mm

Tolerances according to: ISO 2768-m/EN 22768-m

Please visit [www.schaffner.com](http://www.schaffner.com) to find more details on filter connectors.

## Headquarters, Global Innovation and Development

### Switzerland

#### Schaffner Holding AG

Industrie Nord  
Nordstrasse 11e  
4542  
Luterbach  
+41 32 681 66 26  
[info@schaffner.com](mailto:info@schaffner.com)

## Sales and Application Centers

### China

#### Schaffner EMC Ltd. Shanghai

T20-3 C, No 565 Chuangye Road, Pudong district  
201201  
Shanghai  
+86 2138139500  
[cschina@schaffner.com](mailto:cschina@schaffner.com)

### Finland

#### Schaffner Oy

Sauvonrinne 19 H  
8500  
Lohja  
+358 50 468 7284  
[finlandsales@schaffner.com](mailto:finlandsales@schaffner.com)

### France

#### Schaffner EMC S.A.S.

16-20 Rue Louis Rameau  
95875  
Bezons  
+33 1 34 34 30 60  
[francesales@schaffner.com](mailto:francesales@schaffner.com)

### Germany

#### Schaffner Deutschland GmbH

Schoemperlenstrasse 12B  
76185  
Karlsruhe  
+49 721 56910  
[germanysales@schaffner.com](mailto:germanysales@schaffner.com)

### India

#### Schaffner India Pvt. Ltd

Regus World Trade Centre  
WTC, 22nd Floor Unit No 2238, Brigade Gateway Campus, 26/1, Dr. Rajkumar Road Malleshwaram (W)  
560055  
Bangalore  
+91 8067935355  
[indiasales@schaffner.com](mailto:indiasales@schaffner.com)

### Italy

#### Schaffner EMC S.r.l.

Via Ticino, 30  
20900  
Monza (MB)  
+39 039 21 41 070  
[italysales@schaffner.com](mailto:italysales@schaffner.com)

### Japan

#### Schaffner EMC K.K.

ISM Sangenjaya 7F  
1-32-12 Kamiuma, Setagaya-ku  
154-0011  
Tokyo  
+81 3 5712 3650  
[japansales@schaffner.com](mailto:japansales@schaffner.com)

### Singapore

#### Schaffner EMC Pte Ltd.

Blk 3015A Ubi Road 1, #05-09, Kampong Ubi Industrial Estate  
408705  
Singapore  
+65 63773283  
[singaporesales@schaffner.com](mailto:singaporesales@schaffner.com)

### Spain

#### Schaffner EMC España

Calle Caléndula 93, Miniparc III, Edificio E El Soto de Moraleja, Alcobendas  
28109  
Madrid  
+34 917 912 900  
[spainsales@schaffner.com](mailto:spainsales@schaffner.com)

### Sweden

#### Schaffner EMC AB

Östermalmstrorg 1  
114 42  
Stockholm  
+46 8 5050 2425  
[swedensales@schaffner.com](mailto:swedensales@schaffner.com)

### Switzerland

#### Schaffner EMV AG

Industrie Nord  
Nordstrasse 11e  
4542  
Luterbach  
+41 32 681 66 26  
[switzerlandsales@schaffner.com](mailto:switzerlandsales@schaffner.com)

### Taiwan

#### Schaffner EMV Ltd.

U-Town  
20 Floor-2, No 97, Section 1, XinTai 5th Road, XiZhi District  
22175  
New Taipei City  
+886 226975500  
[taiwansales@schaffner.com](mailto:taiwansales@schaffner.com)

### Thailand

#### Schaffner EMC Co. Ltd.

Sathorn Square Tower  
Room 3780, 37FL, 98 North-Sathorn Rd, Silom, Bangrak  
10500  
Bangkok  
+66 621056397  
[thailandsales@schaffner.com](mailto:thailandsales@schaffner.com)

### United Kingdom

#### Schaffner Ltd.

1, Oakmede Place  
Terrace Road  
RG42 4JF  
Binfield  
+44 118 9770070  
[uksales@schaffner.com](mailto:uksales@schaffner.com)

### United States

#### Schaffner EMC Inc.

52 Mayfield Avenue  
Edison, New Jersey  
+1 732 225 9533  
[usasales@schaffner.com](mailto:usasales@schaffner.com)

To find your local partner within Schaffner's global network [schaffner.com](http://schaffner.com)

© 2022 Schaffner Group

The content of this document has been carefully checked and understood. However, neither Schaffner nor its subsidiaries assume any liability whatsoever for any errors or inaccuracies of this document and the consequences thereof. Published specifications are subject to change without notice. Product suitability for any area of application must ultimately be determined by the customer. In all cases, products must never be operated outside their published specifications. Schaffner does not guarantee the availability of all published products. This disclaimer shall be governed by substantive Swiss law and resulting disputes shall be settled by the courts at the place of business of Schaffner Holding AG. Latest publications and a complete disclaimer can be downloaded from the Schaffner website. All trademarks recognized.